

KOPEN®
A L U M I N U M D O O R S

TUTTI I SENSI VENGONO COINVOLTI NEL PROGETTO
KOPEN CON UNA GAMMA DI LINEE CHE RIVELA IN
OGNI AMBIENTE LA PROPRIA ESSENZA.

KOPEN

INDICE

CHI SIAMO	4
SISTEMA STANDARD KDS 100	6
SISTEMA STANDARD KDS 90	14
DIMENSIONI E TIPOLOGIE	20
SICUREZZA MASSIMA	22
TECNOLOGIA AVANZATA	26
QUALITÀ GARANTITA	30
DESIGN ESCLUSIVO	32
<i>LINEA EFFECT</i>	34
<i>LINEA FORM</i>	46
<i>LINEA MATERIKA</i>	50
<i>LINEA VITRUM</i>	56
<i>LINEA LUMIERE</i>	68
<i>LINEA STYLE</i>	72
<i>LINEA PURE</i>	80
<i>LINEA CLASSIC</i>	94
<i>LINEA FRAME</i>	98
<i>LINEA NATURAL</i>	106
ACCESSORI	114
FINITURE	126
VETRI	132

CHI SIAMO

Marchio di riferimento nella progettazione e produzione di porte d'ingresso in alluminio ad alte prestazioni.



K•VISION

Un nuovo modo di immaginare il futuro. Vedere quello che tutti vorrebbero vedere. Porte di ingresso di design, con un cuore in alluminio, che vivono in armonia insieme a chi le sceglie, che comunicano se stesse dentro e fuori con finiture e particolari di qualità che regalano emozioni.

K•MISSION

La Mission che accomuna ogni funzione della nostra azienda è la volontà di essere protagonisti nei nuovi scenari del mercato globale. Il nostro Made in Italy ci rende unici, creiamo porte di ingresso in alluminio capaci di emozionare, coniugando design, tecnologia e sicurezza.

SISTEMA STANDARD KDS 100

Il Sistema KDS 100 è un sistema innovativo ed esclusivo progettato da Kopen per la realizzazione di porte di ingresso in alluminio altamente performanti sia a livello termico che di sicurezza. Il Sistema KDS 100 è un prodotto a taglio termico con barra continua composto da profili estrusi in lega di alluminio di primaria qualità con un telaio da 84mm ed un'anta con una sezione da 98/102/121 a seconda della soluzione scelta. Tutte le porte di ingresso Kopen sono provviste di marcatura CE secondo la normativa UNI EN 14351-1 e sono in possesso delle seguenti prestazioni.

PRESTAZIONI



TENUTA ALL'ACQUA
(UNI EN 1027,12208)
fino a Classe 9A



ABBATTIMENTO ACUSTICO
(UNI EN ISO 140-3, UNI EN ISO 717-1)
fino a Classe a 40 dB



RESISTENZA AL VENTO
(UNI EN 12211,12210)
fino a Classe C4



PERMEABILITÀ ALL'ARIA
(UNI EN 1026,12207)
fino a Classe 4



RESISTENZA ALL'EFFRAZIONE
(UNI EN 1627-28-29-30)
RC2, RC3, RC4

RISPARMIO ENERGETICO

Il sistema KDS 100 è stato progettato per garantire il massimo delle performance in termini di risparmio energetico per la realizzazione di una porta di ingresso in grado di soddisfare ampiamente i requisiti richiesti dalle normative vigenti.



TRASMITTANZA TERMICA
(UNI EN ISO 12567-2)
fino a Ud 0,68 W/mq°K

Il Sistema Standard prevede anta e telaio complanari all'esterno con 3 cerniere a vista a 2 ali in alluminio in tinta con pannello interno e telaio.



TABELLA SPESSORI ANTA KDS 100

RIVESTIMENTO ESTERNO	RIVESTIMENTO INTERNO		
	ALU 2.5 mm	WD 7 mm	WD 14 mm
ALU 2.5 mm	SA = 98 mm	SA = 102 mm	SA = 109 mm
WD 14 mm	SA = 109 mm	SA = 114 mm	SA = 121 mm

CONFIGURAZIONE DI SERIE

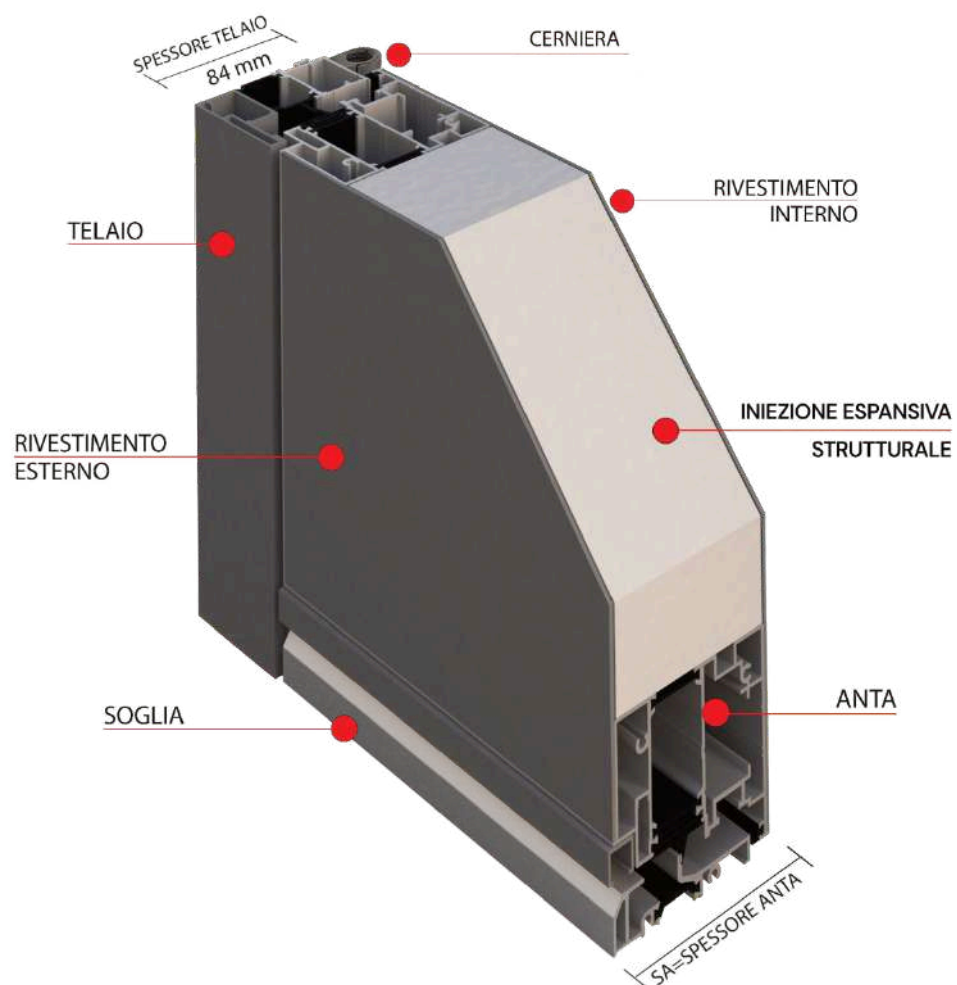

CILINDRO EUROPEO FRIZIONATO 5 CHIAVI + CHIAVE DA CANTIERE

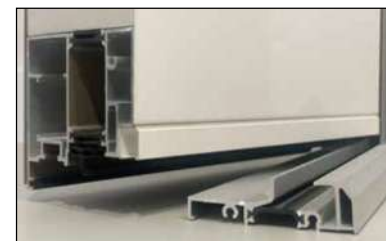

SOGLIA RIBASSATA OSSIDATO ARGENTO O NERO CON ALTEZZA 24 MM



3 CERNIERE A 2 ALI IN ALLUMINIO IN TINTA



SERRATURA MECCANICA GANCI E PUNZONI A 3 PUNTI



ANELLO DEFENDER DI SICUREZZA



MANIGLIA INTERNA E POMOLO ESTERNO IN ALLUMINIO ARGENTO

OPZIONI

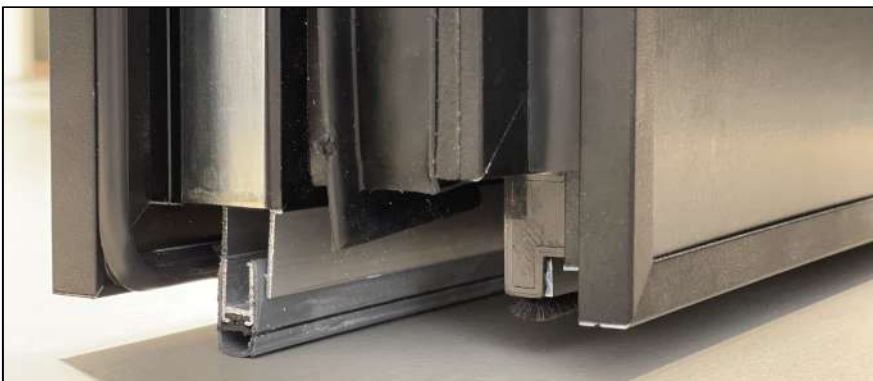

SOGLIA MOBILE (PARASPIFFERI)

Prestazioni ridotte di tenuta all'acqua (1A), permeabilità all'aria (classe 2) e Resistenza al Vento (classe C3)

IL KIT MIGLIORAMENTO TERMICO DEI PROFILI CONSENTE DI RIDURRE LA TRASMITTANZA TERMICA DELLA PORTA FINO A 0.68 W/MQ°K



SERRATURA MECCANICA 5 PUNTI



SERRATURA RIARMO AUTOMATICO 3 E 4 PUNTI (MOTORIZZABILE)

SOLUZIONI



KDS 100

TELAIO INT/EST in alluminio
PANNELLI INT/EST in alluminio spessore 2,5 mm



KDS 100 WD7

TELAIO INT/EST in alluminio
PANNELLO EST. in alluminio spessore 2,5 mm
PANNELLO INT. in laminato spessore 7 mm



KDS 100 WD14I

TELAIO EST in alluminio
TELAIO INT. rivestito in legno okoumè
PANNELLO EST. in alluminio spessore 2,5 mm
PANNELLO INT. in legno okoumè spessore 14 mm



KDS 100 WD14E

TELAIO EST. rivestito in legno okoumè
TELAIO INT. in alluminio
PANNELLO EST. in legno okoumè spessore 14 mm
PANNELLO INT. in alluminio spessore 2,5 mm



KDS 100 WD14 / WD7

TELAIO EST. rivestito in legno okoumè
TELAIO INT. in alluminio
PANNELLO EST. in legno okoumè spessore 14 mm
PANNELLO INT. in laminato spessore 7 mm



KDS 100 WD14 / WD14

TELAIO INT/EST. rivestito in legno okoumè
PANNELLO INT/EST. in legno okoumè spessore 14 mm

SISTEMA GHOST KDS 100 GH



Il sistema GHOST prevede anta (98/121 mm) e telaio (96 mm) complanari sia interno che esterno grazie alla dotazione delle cerniere a scomparsa che consentono apertura a 180° con portata fino a 160 kg.

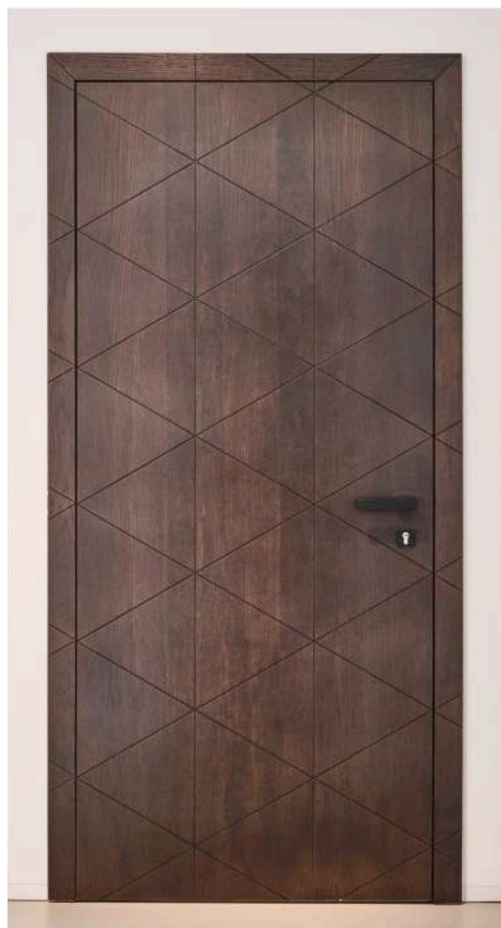

SISTEMA BILICO KDS 100 BI

Il sistema BILICO prevede anta (98/121 mm) e telaio (96 mm) complanari sia interno che esterno e permette di realizzare porte di dimensioni fino a 2100x3400 mm grazie alle cerniere con portata fino a 500 kg.



PORTA A VETRO

KDS 100

LINEE VITRUM – EFFECT VETRATE – FRAME VETRATE



VETROCAMERA con dimensioni variabili in base al modello realizzato con 3 CAMERE e 4 LASTRE DI VETRO, spessore totale 92 mm. Semicomplanare all'anta di spessore 98 mm.

COMPOSIZIONE DEL VETROCAMERA STANDARD:
33.1 PL. SAT/C/4/C/4 B.E./C/33.1 PL. SAT (J22)

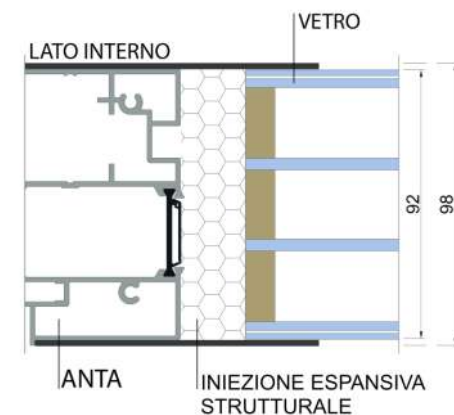

LINEA LUMIERE (LUO1KP)

VETROCAMERA con massima dimensione realizzato con 1 o 2 CAMERE e CON 2 o 3 LASTRE DI VETRO, Spessore totale 38 mm o 52 mm. Semicomplanare sul lato esterno e con fermavetro interno (non rimovibile).

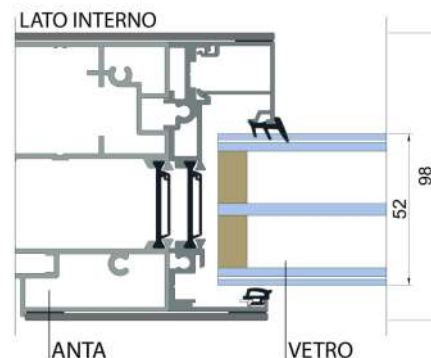

VETROCAMERA DA 38 mm per misure SPECIAL



COMPOSIZIONE DEL VETROCAMERA DA 52 mm: 33.1 PL. SAT/C/4 B.E./C/33.1PL. SAT (J22)

FIANCOLUCE | SOPRALUCE

KDS 100

Le tipologie FIANCOLUCE e SOPRALUCE sono prodotte separatamente e disponibili con telaio standard da 48 mm e maggiorato da 71 mm.

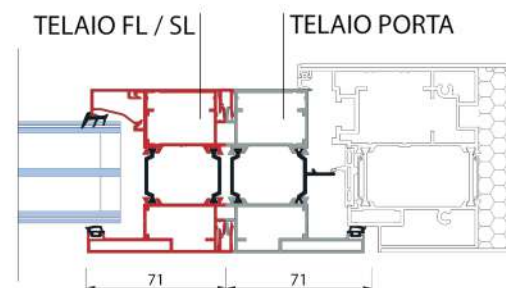
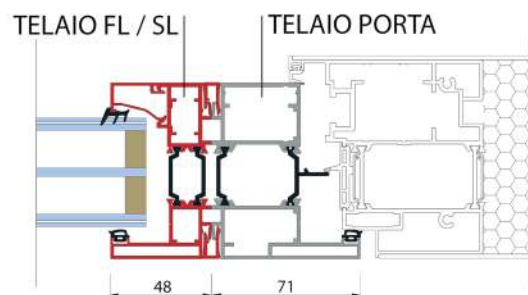
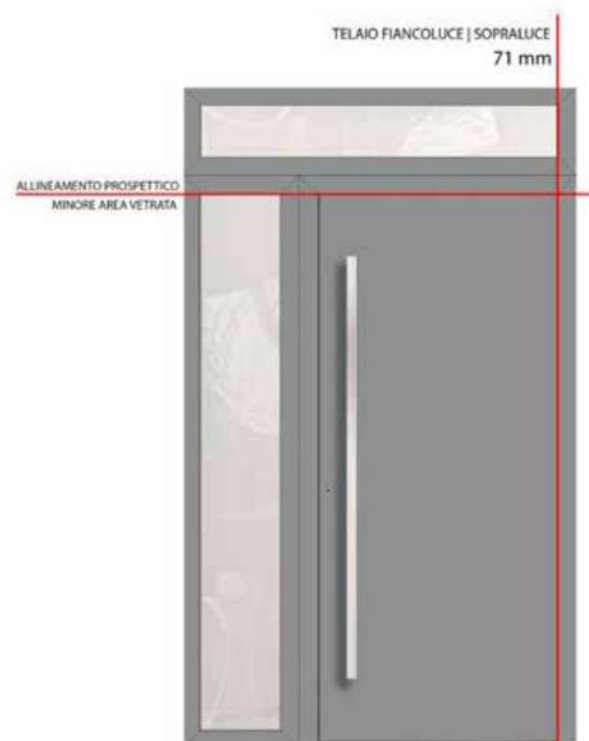
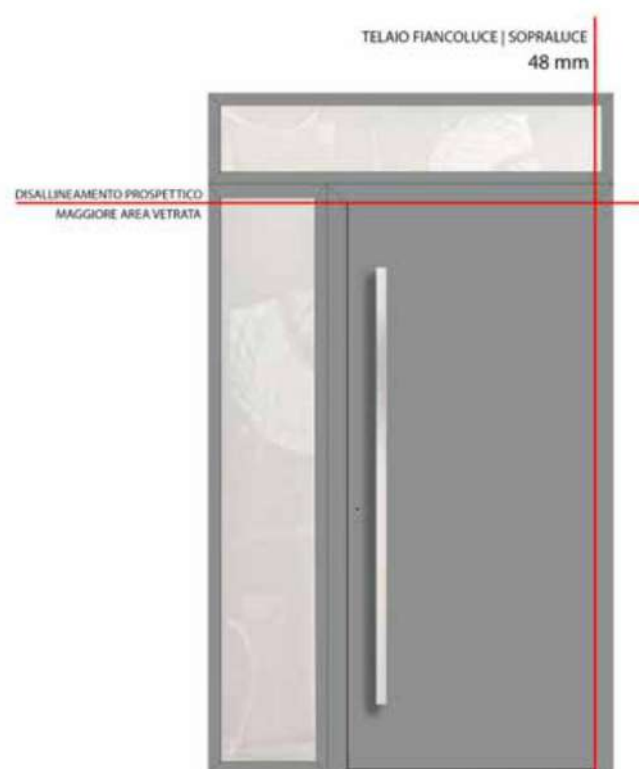

COMPOSIZIONE DEL VETROCAMERA DA 52 mm: 33.1 PL. SAT/C/4/C/33.1 PL. SAT (J22)

Per i sistemi GHOST e BILICO non è possibile avere l'allineamento prospettico essendo il telaio della porta di 89 mm.

SISTEMA STANDARD KDS 90

Il sistema KDS 90 STANDARD è un sistema progettato da Kopen realizzato con profilati estrusi in lega di alluminio UNI 6060 a taglio termico con telaio da 84/71 mm ed anta da 78 mm. Il sistema di tenuta è a 3 guarnizioni per garantire il massimo delle prestazioni. Tutte le porte sono provviste di marcatura CE secondo la normativa UNI EN 14351-1 e sono in possesso delle seguenti prestazioni

PRESTAZIONI



TENUTA ALL'ACQUA
(UNI EN 1027,12208)
E1200



RESISTENZA ALL'EFFRAZIONE
(UNI EN 1627:2011)
Fino a RC3



RESISTENZA AL VENTO
(UNI EN 12211,12210)
Classe C5



PERMEABILITÀ ALL'ARIA
(UNI EN 1026,12207)
Classe 4

RISPARMIO ENERGETICO

Il sistema KDS 90 è stato progettato per garantire performance elevate in termini di risparmio energetico per la realizzazione di una porta di ingresso in grado di soddisfare ampiamente i requisiti richiesti dalle normative vigenti.



TRASMITTANZA TERMICA
(UNI EN ISO 12567-2)
Fino a Ud 0,79 W/mq°K

Il Sistema Standard prevede 4 tipologie di telaio con 2 cerniere a tre ali e due tipologie di anta. È possibile ottenere complanarità interna ed esterna.



TABELLA SPESSORI ANTA KDS 90

	KDS 90 STD	KDS 90 SRD	KDS 90 SRE	KDS 90 SRI	KDS 90 SRC
SPESSORE ANTA	SA = 78mm	SA = 78mm	SA = 85mm	SA = 78mm	SA = 85mm
SPESSORE LAMIERA	SL = 1,5mm	SL = 1,5mm	SL = 1,5mm	SL = 1,5mm	SL = 1,5mm

CONFIGURAZIONE DI SERIE

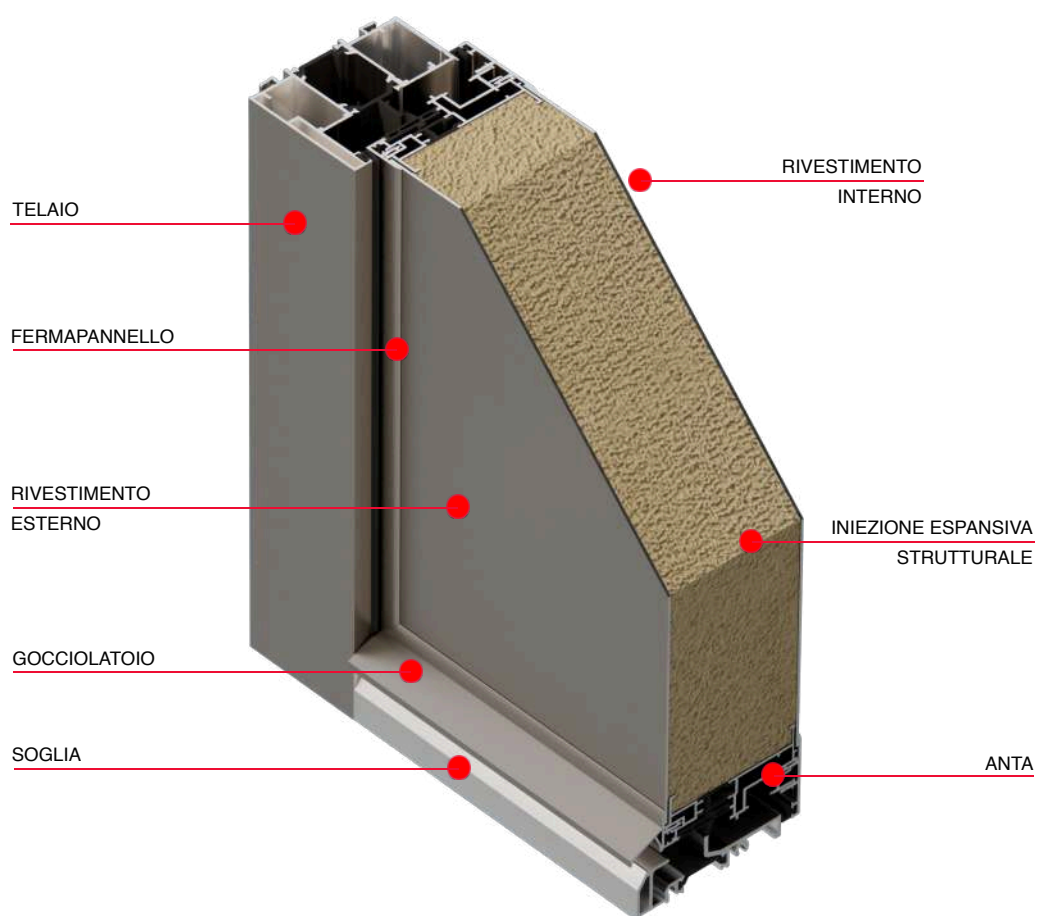

CILINDRO EUROPEO FRIZIONATO 5 CHIAVI + CHIAVE DA CANTIERE



SOGLIA RIBASSATA OSSIDATO ARGENTO O NERO CON ALTEZZA 24 MM



2 CERNIERE 3D A 2 ALI IN ACCIAIO ZINCATO CON CAPPUCCI IN ALLUMINIO IN 5 FINITURE



SERRATURA MECCANICA CON INCONTRI SCIOLTI + GANCI E PUNZONI A 3 PUNTI



ANELLO DEFENDER DI SICUREZZA



MANIGLIA INTERNA E POMOLO ESTERNO IN ALLUMINIO ARGENTO

FINITURE CERNIERE IN ALLUMINIO



Bianco 9016



Nero 9005 OP



Argento Satinato



Bronzo Satinato



Ottone Lucido

OPZIONI



SOGLIA MOBILE (PARASPIFFERI)

Tipologia non certificata per uso esterno ma solo per l'installazione su pianerottolo. Nessuna prestazione dichiarata di tenuta acqua, aria e vento.



CERNIERA A 3 ALI

Optional su telaio standard, di serie su telaio super ridotto.

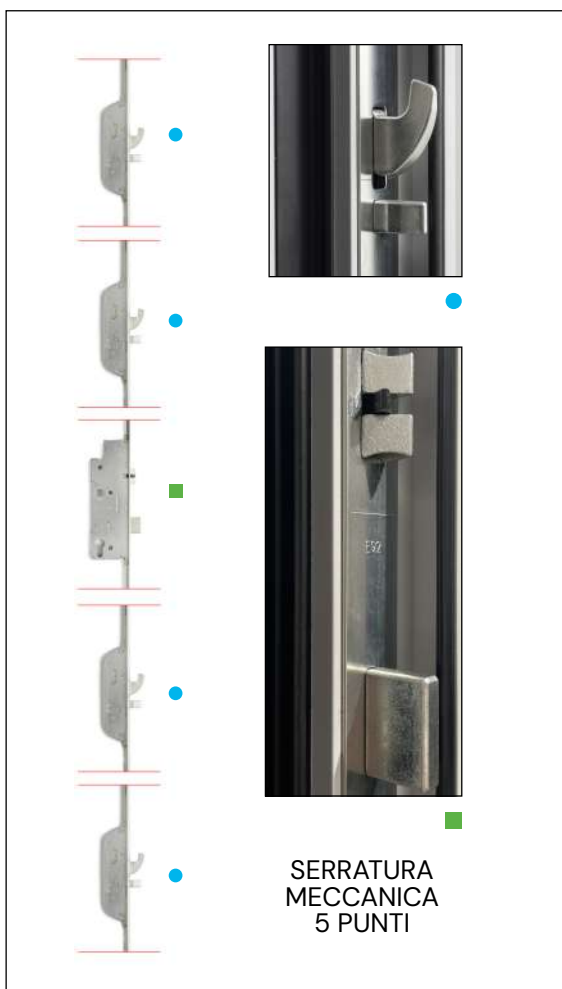

SERRATURA MECCANICA 5 PUNTI



SERRATURA RIARMO AUTOMATICO 3 E 4 PUNTI (MOTORIZZABILE)

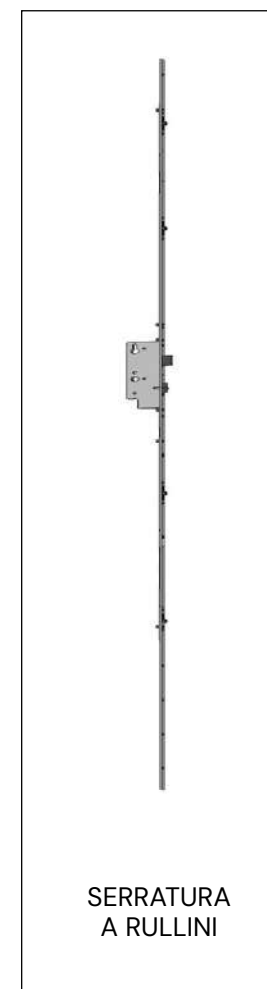

SERRATURA A RULLINI

SOLUZIONI



KDS 90 SRD

TELAIO SUPER RIDOTTO 45 MM



KDS 90 SRI

TELAIO SUPER RIDOTTO 45 MM
Complanare interno



KDS 90 SRE

TELAIO SUPER RIDOTTO 45 MM
Complanare esterno



KDS 90 SRC

TELAIO SUPER RIDOTTO 45 MM
Complanare interno ed esterno

PORTA A VETRO

KDS 90

LINEA VITRUM

VETROCAMERA con dimensioni variabili in base al modello realizzato con 2 CAMERE e 3 LASTRE DI VETRO, spessore totale 73 mm.
Semicomplanare all'anta di spessore 78 mm.



COMPOSIZIONE DEL VETROCAMERA STANDARD:
33.1 PL. SAT/C/4 B.E./C/33.1 PL. SAT (J22)

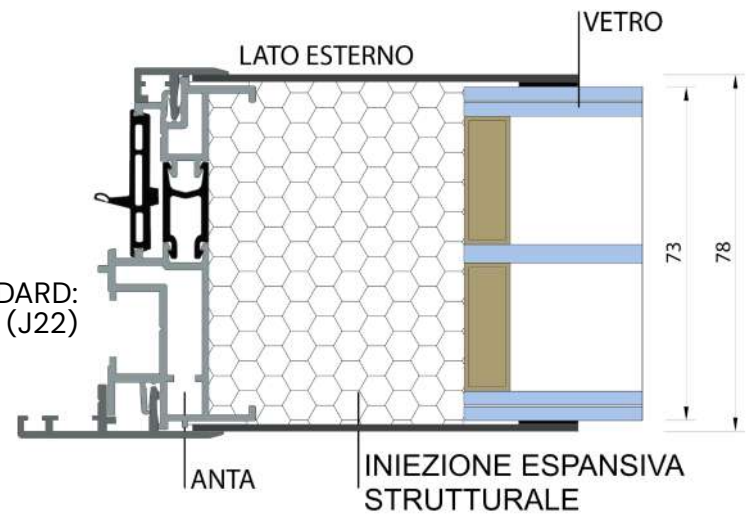

FIANCOLUCE | SOPRALUCE

KDS 90

Le tipologie FIANCOLUCE e SOPRALUCE sono prodotte separatamente e disponibili con telaio standard da 48 mm e maggiorato da 71 mm.

COMPOSIZIONE DEL VETROCAMERA DA 52 MM: 33.1PL. SAT/C/4/C/33.1PL. SAT (J22)

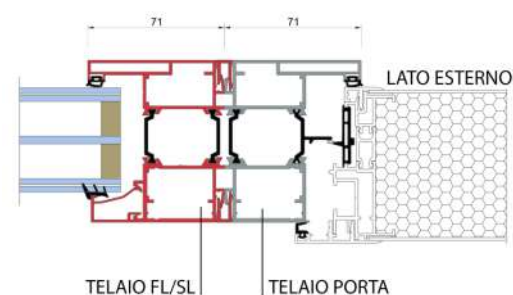
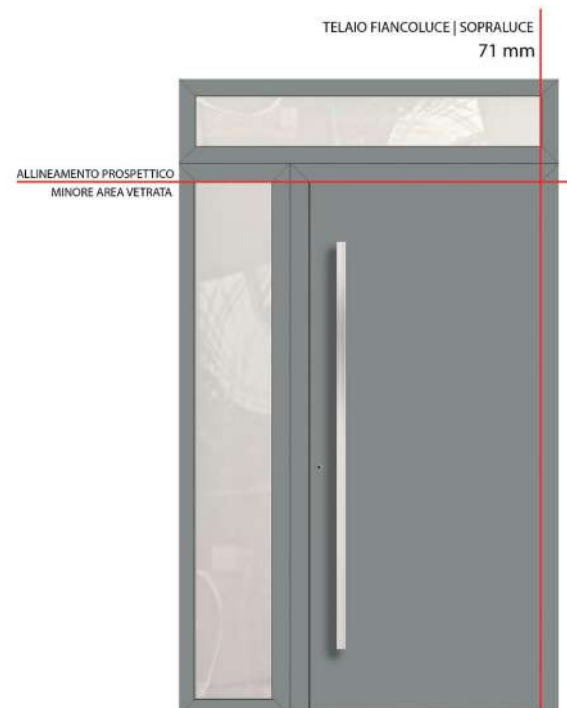
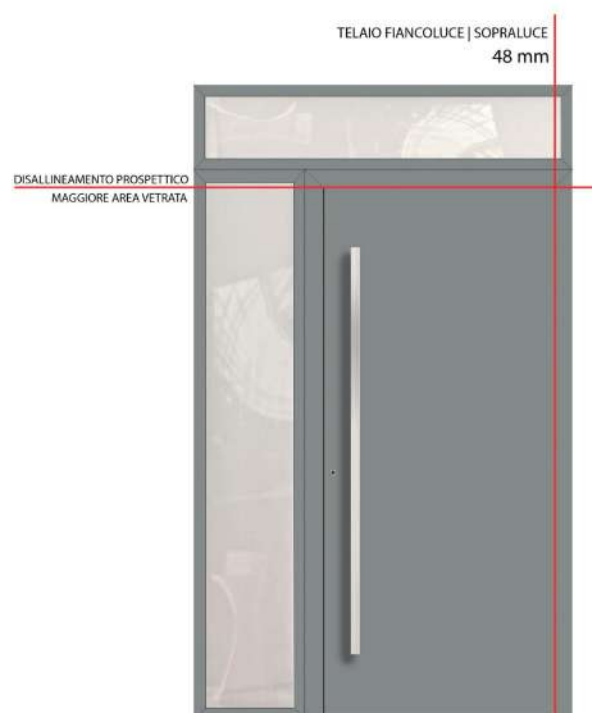

Il sistema Kopen garantisce la massima libertà progettuale anche per la possibilità di scegliere diverse configurazioni di prodotto combinando le varie tipologie (che per facilitare movimentazione, trasporto e montaggio, sono consegnati separatamente nell'imballo), quali fianchiluce fissi e sopraluce fissi (squadriati o centinati) o apribili a wasistas.

DIMENSIONI E TIPOLOGIE

La porta di ingresso in alluminio Kopen nasce per soddisfare al meglio ogni esigenza ed è per questo che ogni prodotto è realizzato sempre su misura dando vita ad un modello unico.

Le dimensioni sono da considerarsi standard sino a 1.060 x 2.250 mm (dimensioni riferite alla singola anta esterno telaio), con la possibilità di realizzare modelli fino a 1.300 x 2.500 mm (FORMATO SPECIAL 1), inclusa l'opportunità di scegliere il FORMATO SPECIAL 2 con altezza sino a 2.800 mm (misure riferite al Sistema KDS 100). Con la soluzione BILICO, inoltre, può essere realizzata una porta ad un'anta fino a 2.100 x 3.400 mm (solo per i modelli della Linea EFFECT).



Il sistema Kopen garantisce la massima libertà progettuale anche per la possibilità di scegliere diverse configurazioni di prodotto combinando le varie tipologie (che per facilitare movimentazione, trasporto e montaggio, sono consegnati separatamente nell'imballo), quali fianchiluce fissi e sopra luce fissi (squadri o centinati) o apribili a wasistas ed anta secondaria simmetrica o asimmetrica.

KDS 90 **KDS 100**

KDS 100

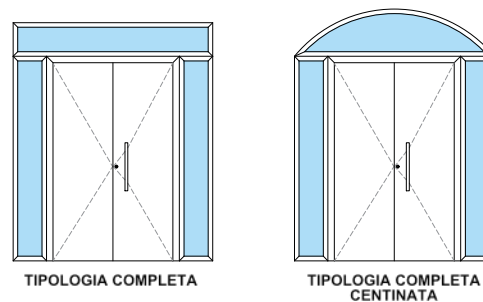
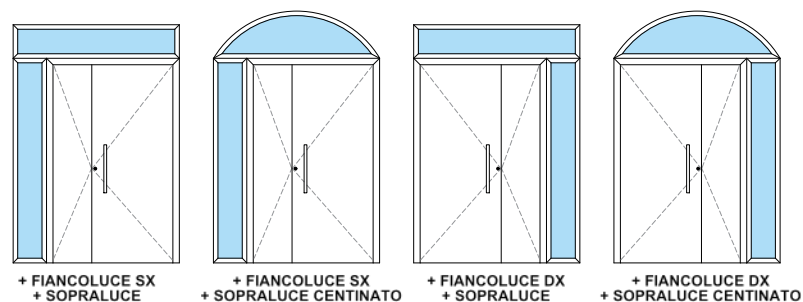
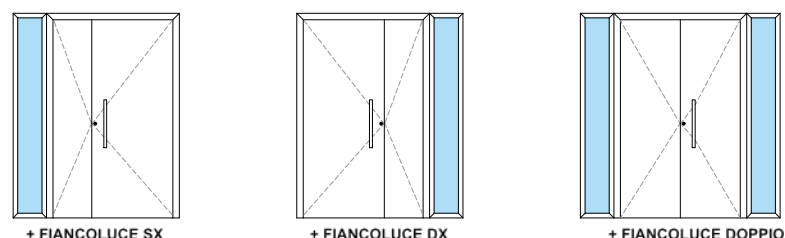
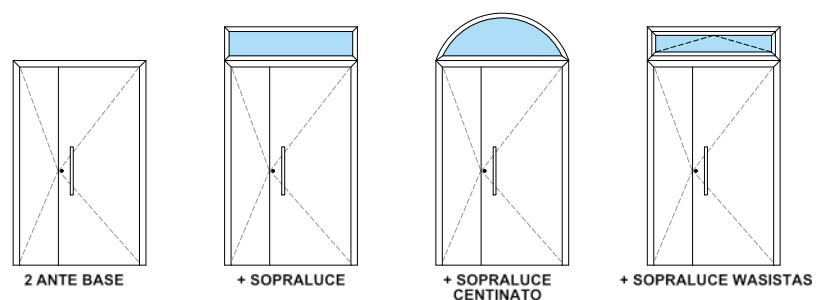
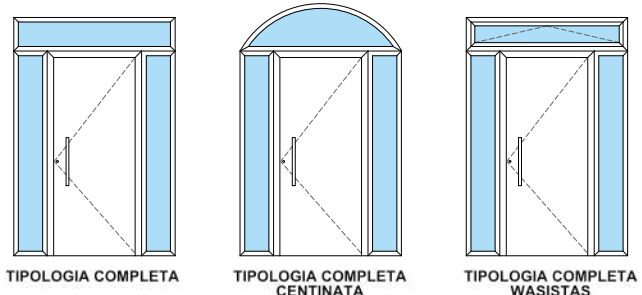
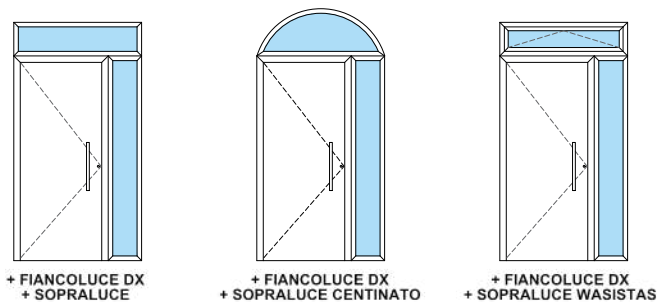
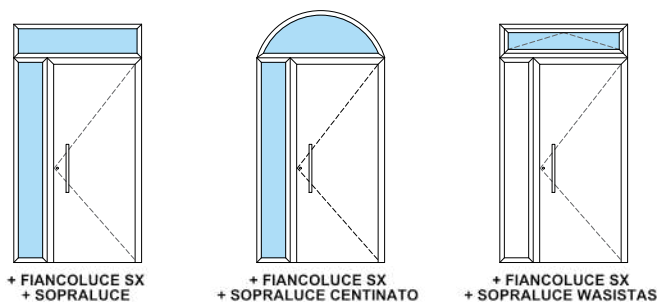
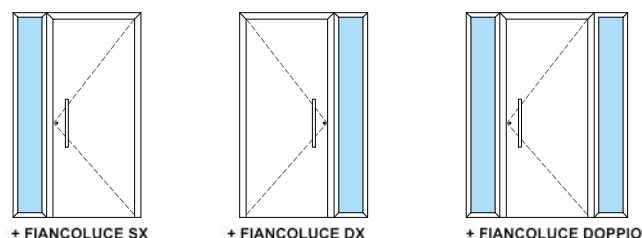
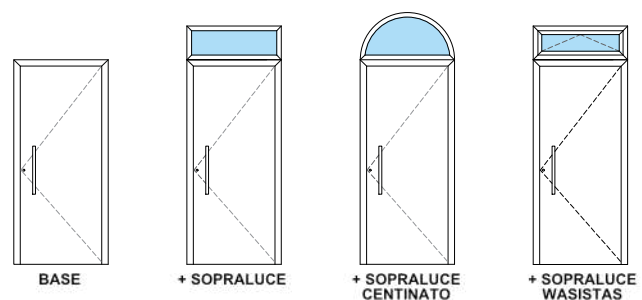

SICUREZZA MASSIMA

La scelta di una porta di ingresso Kopen vuol dire scegliere il massimo della sicurezza e della tecnologia per un prodotto sicuro di nuova generazione.



Le porte di sicurezza Kopen sono progettate e costruite per resistere ai tentativi di effrazione per garantire la massima sicurezza e possono offrire protezione antieffrazione secondo la norma EN 1627-1630 nelle classi di resistenza certificate RC2, RC3 ed RC4.

ROSTRO ANTIEFFRAZIONE
ACCIAIO INOX
(OPTIONAL KDS 100)

CERNIERA 3 ALI ALLUMINIO
(OPTIONAL KDS 100)



IL CILINDRO

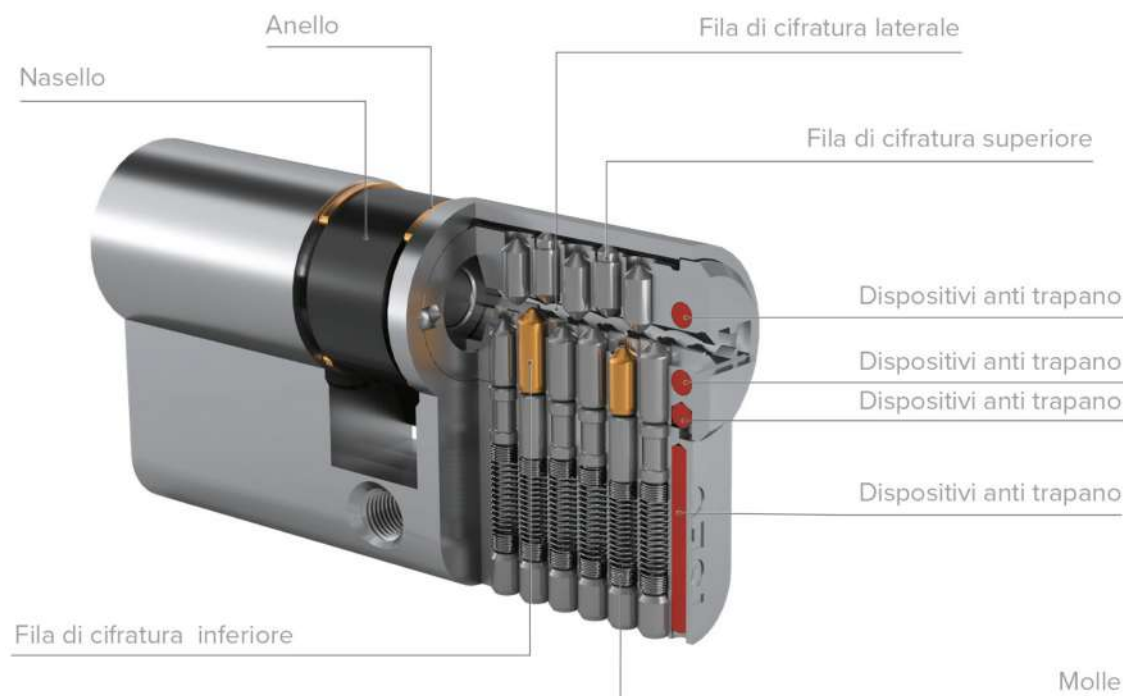





Il cilindro di sicurezza frizionato R700 è un cilindro a profilo europeo e offre un livello di sicurezza superiore (certificato fino alla classe RC4), disponibile nelle versioni a chiave diversa (1 chiave cantiere + 5 chiavi padronali) e a chiave unificata (KA) per più accessi (adatto anche a sistemi master key multilivello)

Le chiavi R700 sono realizzate in ottone rivestito e un cappuccio in plastica ergonomico verde opalino.

Caratteristiche di sicurezza:

- Sistema di cifratura a **15 perni in acciaio inox** (su 3 file di cifratura)
- Protezione resistente alla perforazione con **trapano**
- Protezione **antipicking** integrata nel cilindro profilato
- Protezione **antibumping**



VERSIONE	LINEE	DOTAZIONE	OPTIONAL
  STANDARD	Tutti i modelli porte Vitrum	Serratura meccanica a 3 punti di chiusura Cilindro frizionato a 5 chiavi a cifratura protetta certificato antieffrazione RC4 KDS 90: N°2 cerniere a 2 ali in acciaio KDS 100: N°3 cerniere a 2 ali in alluminio	Serratura meccanica a 5 punti di chiusura Serratura a riarmo automatico a 3 punti di chiusura (motorizzabile) Serratura a riarmo automatico a 4 punti di chiusura (motorizzabile) Rostri in acciaio lato cerniere (solo KDS 100)
 	Porte Vitrum (escluso vetri curvi e modelli LU01KP - V113KP)	Serratura meccanica a 3 punti di chiusura Cilindro frizionato a 5 chiavi a cifratura protetta certificato antieffrazione RC4 KDS 100: N°3 cerniere a 2 ali in acciaio	Serratura meccanica a 5 punti di chiusura Serratura a riarmo automatico a 3 punti di chiusura (motorizzabile) Serratura a riarmo automatico a 4 punti di chiusura (motorizzabile) Rostri in acciaio lato cerniere
  	Tutti i modelli porte cieche	Serratura meccanica a 3 punti di chiusura Cilindro frizionato a 5 chiavi a cifratura protetta certificato antieffrazione RC4 KDS 90: N°2 cerniere a 2 ali in acciaio KDS 100: N°3 cerniere a 2 ali in alluminio	Serratura meccanica a 5 punti di chiusura Serratura a riarmo automatico a 3 punti di chiusura (motorizzabile) Serratura a riarmo automatico a 4 punti di chiusura (motorizzabile) Rostri in acciaio lato cerniere (solo KDS 100) Piatti di rinforzo su anta e telaio (solo KDS 100)
 	Porte Vitrum (escluso vetri curvi e modelli LU01KP - V113KP)	Serratura meccanica a 5 punti di chiusura Cilindro frizionato a 5 chiavi a cifratura protetta certificato antieffrazione RC4 3 cerniere a 2 ali in alluminio Rostri in acciaio lato cerniere Piatti di rinforzo su anta e telaio	Serratura a riarmo automatico a 3 punti di chiusura (motorizzabile) Serratura a riarmo automatico a 4 punti di chiusura (motorizzabile)
 	Tutti i modelli porte cieche	Serratura meccanica a 5 punti di chiusura Cilindro frizionato a 5 chiavi a cifratura protetta certificato antieffrazione RC4 3 cerniere a 2 ali in acciaio Rostri in acciaio lato cerniere Piatti di rinforzo su anta e telaio Rinforzo interno pannello	Serratura a riarmo automatico a 4 punti di chiusura (motorizzabile)

Nota: Le Porte con cerniere a scomparsa, bilico, tipologie a 2 ante, linee Materika e Natural non sono certificate Antieffrazione



TECNOLOGIA AVANZATA



Controllo intelligente, perfettamente integrato nel portoncino

La nuova generazione dei dispositivi di comando R8 è progettata per integrarsi con naturalezza nel design dei portoncini in alluminio Kopen. Funzioni avanzate, materiali di qualità e dettagli essenziali convivono in un equilibrio perfetto tra estetica e innovazione. I lettori offrono diverse modalità di gestione e funzioni, a seconda della versione scelta:

- R8 EASY ideale per controllo accessi con app vicino alla porta o con collegamenti domotici. Disponibile soltanto con cover color INOX.
- R8 ideale per gestione e controllo accessi da remoto. Disponibile sia con cover color INOX che nera.



Aprire diventa un gesto naturale

COVER
INOX

COVER
NERA



LETTORE IMPRONTE DIGITALI R8 (BIOMETRICO)

Fino a **166 persone**



LETTORE TOUCHPAD R8

Fino a **100 codici numerici** (da 4 a 16 cifre)

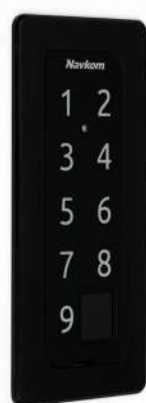

LETTORE BIO-TOUCHPAD R8

Fino a **50 impronte digitali e 50 codici numerici**

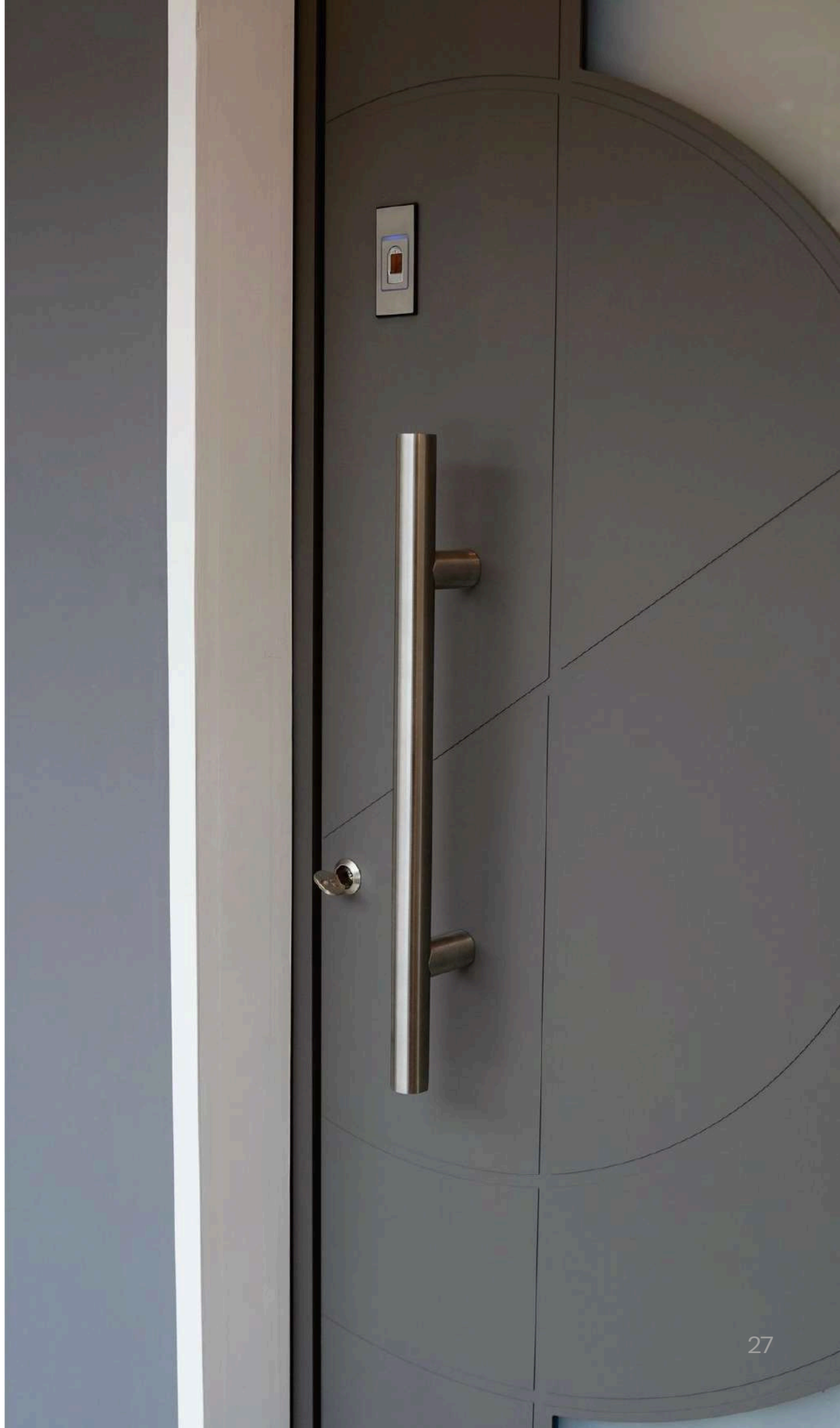

CONTROLLO REMOTO TRAMITE APP

L'app NSatellite permette di gestire il portoncino Kopen ovunque ci si trovi. Tutte le connessioni remote avvengono tramite protocolli protetti con crittografia avanzata mobile GSM/LTE e Wi-Fi.



Apertura remota che sblocca la porta da qualsiasi luogo.



Gestione utenti personalizzata con codici e impronte.



Notifiche in tempo reale sullo stato della porta.



Storico attività con registro degli accessi e registrazione degli eventi.

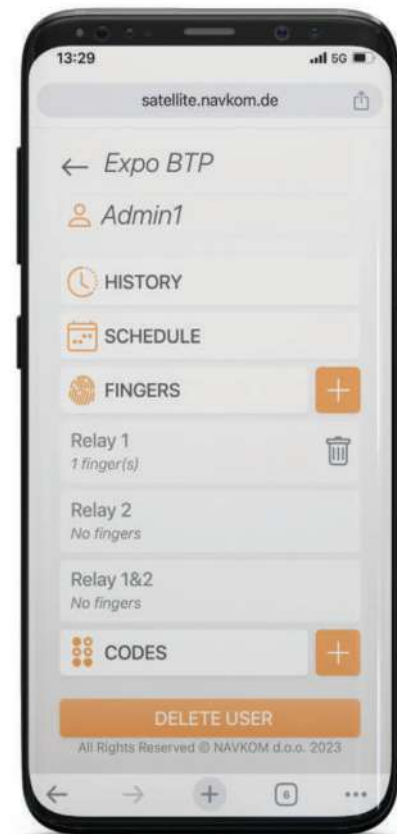

N Satellite

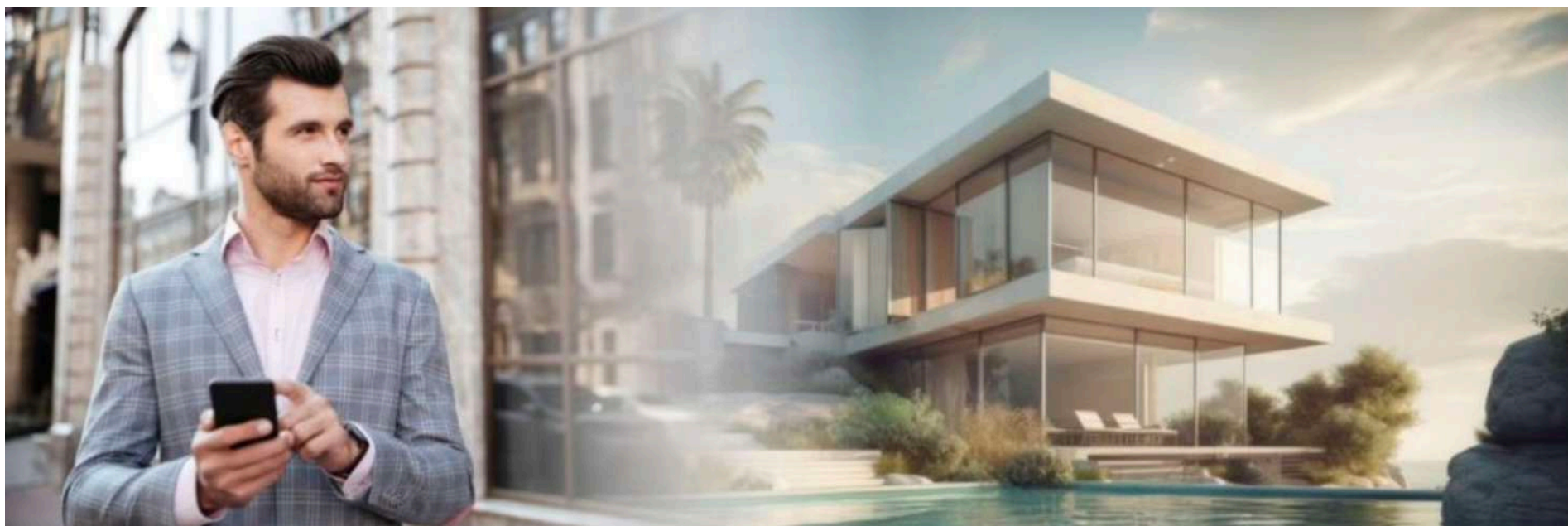

GESTIONE DI ALLOGGI TURISTICI

Risparmio di tempo e gestione semplificata: gli ospiti accedono in autonomia all'alloggio tramite codice o smartphone, mentre il controllo resta sempre disponibile, ovunque ci si trovi.

- ✓ Apertura porta da remoto tramite l'app – ovunque e in qualsiasi momento.
- ✓ Possibilità di aggiungere, modificare e cancellare codici da remoto.
- ✓ Abilitazione apertura per telefono (concedere l'accesso via e-mail).
- ✓ Impostazione orari di accesso per gli utenti (ad esempio, addetti alle pulizie, fattorini, babysitter).
- ✓ Impostazione per l'accesso limitato nel tempo degli utenti o limitare il numero di ingressi.
- ✓ Visualizzazione della cronologia degli eventi: inserimenti di utenti, tentativi di inserimento non riusciti.
- ✓ Gestione passaggio libero per tutti gli utenti.
- ✓ Gestione dell'illuminazione della porta (orario di accensione/ spegnimento e livello di luminosità).
- ✓ Ricezione notifiche dall'app quando la porta si apre.
- ✓ Aggiornamento del software da remoto con le ultime funzionalità.



QUALITÀ GARANTITA

Scegliere una porta di ingresso Kopen vuol dire scegliere un prodotto resistente, di qualità, garantito per durare nel tempo.

GARANZIA

Le porte Kopen nascono per trasformare ogni abitazione in uno spazio esclusivo, dove design, sicurezza e qualità convivono in perfetta armonia. Ogni modello racchiude l'eccellenza del Made in Italy e il know-how Kopen, frutto di una costante ricerca di innovazione, affidabilità e cura dei dettagli. Per offrire la massima tranquillità nel tempo, le porte Kopen sono garantite per 15 anni sulla piena funzionalità dei componenti e sulla qualità della verniciatura.



CERTIFICAZIONI

Kopen ha sviluppato un controllo qualità sull'intero processo produttivo, dalla progettazione fino all'imballo e consente di ottimizzare i processi e assicurare il rispetto degli standard del prodotto. Tutti i prodotti sono certificati presso laboratori nazionali ed internazionali del settore per garantire la massima qualità.

gbl LAB

Rapporto di prova / Prüfbericht
 Prova di accensione secondo EN 13396-2 (Paral)
 Indotabile con EN 13396-2 (Paral)
 Permeabilità all'aria secondo EN 10240
 Luminosità secondo EN 10240
 Tenuta all'incendio secondo EN 10247
 Antispiaccatura secondo EN 10247
 Resistenza al calore del rivestimento secondo EN 12219
 Microscopia secondo EN 12219

Richiedente Autoregolare	KOPEN s.r.l.	Indirizzo Sede	Via SS 9 Via Salaria, 87040 Auletta (AZ)
Tipologia Requisiti	Autoregolazione all'aria senza V-Reg. Test	Dimensionamento parametri	R20 100
Spessore strati membrana	Struttura membrana	Dimensioni membrana	Larghezza / Area Spessore / max. 1110 mm 2180 mm
Norme prodotte Prodotto	Faccende e porte Faccende con Grate	EN 14281-1	
Valutazione conforme	Struttura di protezione membrana	EN 12217	4
Valutazione conforme	Permeabilità all'aria (senza membr.) Luminosità (membrana) Tenuta all'incendio Antispiaccatura	EN 14281-1 EN 10240 EN 10247 EN 10247	4 4 4 4
Valutazione conforme	Resistenza al calore del rivest. Microscopia secondo EN 12219	EN 12210	CA

gbl LAB

gbl LAB

Rapporto di prova / Prüfbericht
 Misurazione della resistenza al vento e
 resistenza all'urto secondo EN 12217
 Carico statico in conformità alla norma EN 1928
 Metodo Windung nach EN 1928
 Resistenza all'urto secondo EN 12217
 Metodo Impactung nach EN 12217

Committente Autoregolare	KOPEN s.r.l.	Indirizzo Sede	Via SS 9 Via Salaria, 87040 Auletta (AZ)
Descrizione Requisiti	Prova ad urto statico Carico statico	Identificazione normativa	EN 12217
Materiali usati Autoregolabile	Membrana Membrana	Dimensioni Riduzione	Larghezza / Area Spessore / max. 1110 mm 2175 mm
Nome di azienda Prodotto	Faccende e porte Faccende con Grate	EN 14281-1	
Classificazione oggetto di prova Prodotto	Carico statico Metodo Windung	EN 1927	4
Prodotto	Resistenza all'urto secondo Metodo Impactung	EN 12217	4

gbl LAB

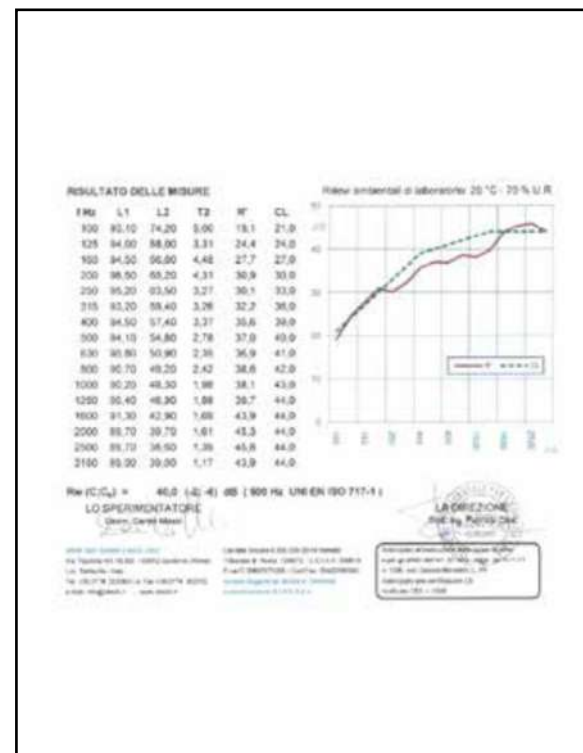

ASSISTENZA E FORMAZIONE

Per soddisfare ogni esigenza Kopen vanta uno staff dedicato all'assistenza pre e post vendita. Dalla fase di preventivazione ordine con l'esclusivo CONFIGURATORE fino alla posa in opera, il personale qualificato è in grado di fornire tutto il supporto necessario.



DESIGN ESCLUSIVO

La scelta di una porta di ingresso Kopen vuol dire scegliere la libertà progettuale per un prodotto di design, su misura, che viva in armonia con il proprio ambiente.

Le nuove ed esclusive collezioni, frutto di un lungo e laborioso lavoro di un team di designer e progettisti, nascono per soddisfare ogni esigenza architettonica e di arredamento.



IL DESIGN CHE SEGUE LE DIMENSIONI

Il design delle porte KOPEN si adatta alle dimensioni del prodotto con delle regole di riproporzionamento del disegno, mantenendo identità di progetto e conciliando estetica ed industrializzazione.



RICONOSCIMENTI

- **2018 | Oscar del Serramento** per la categoria "Porte d'Ingresso" con le serie Ghost e Bilico
- **2019 | YED Award** per la menzione speciale al "Miglior Prodotto Finito" con la serie Bilico
- **2022 | Oscar del Serramento** per la categoria "Effortless" con il prodotto EF18KP
- **2025 | Awards del Serramento** per la categoria "Porte d'Ingresso e Portoni da Garage" con il prodotto PU27KP



LINEA **EFFECT**

Con una sapiente scelta e combinazione di finiture ed effetti, gli esclusivi modelli della linea EFFECT di Kopen si trasformano per adattarsi ai diversi stili di ogni esigenza architettonica, dalle ristrutturazioni alle nuove costruzioni.





EF 17 KP

KDS 100

FINITURA

7037 R TX / 7035 R TX / 9006 R TX

MANIGLIONE

MSX E23 J05 (L 1600 MM / I 1575 MM)



EF 16 KP

KDS 100

FINITURA

PK A16

MANIGLIONE

MSX E23 J05 (L 1600 MM / I 1575 MM)

INSERTO

ALLUMINIO INOX SATINATO (20 MM)



EF 14 KP

KDS 100

FINITURA

9006 R TX / 7039 R TX / 9016 R TX

MANIGLIONE

MSX E23 J02 (L 1600 MM / I 1575 MM)

INSERTO

NERO OPACO (20/60 MM)



EF 04 KP

KDS 100

FINITURA
1013 R TX

MANIGLIONE
MSX E27 J05

INSERTO
INOX SATINATO

LAVORAZIONE
PANTOGRAFATO FRESATO (6mm)

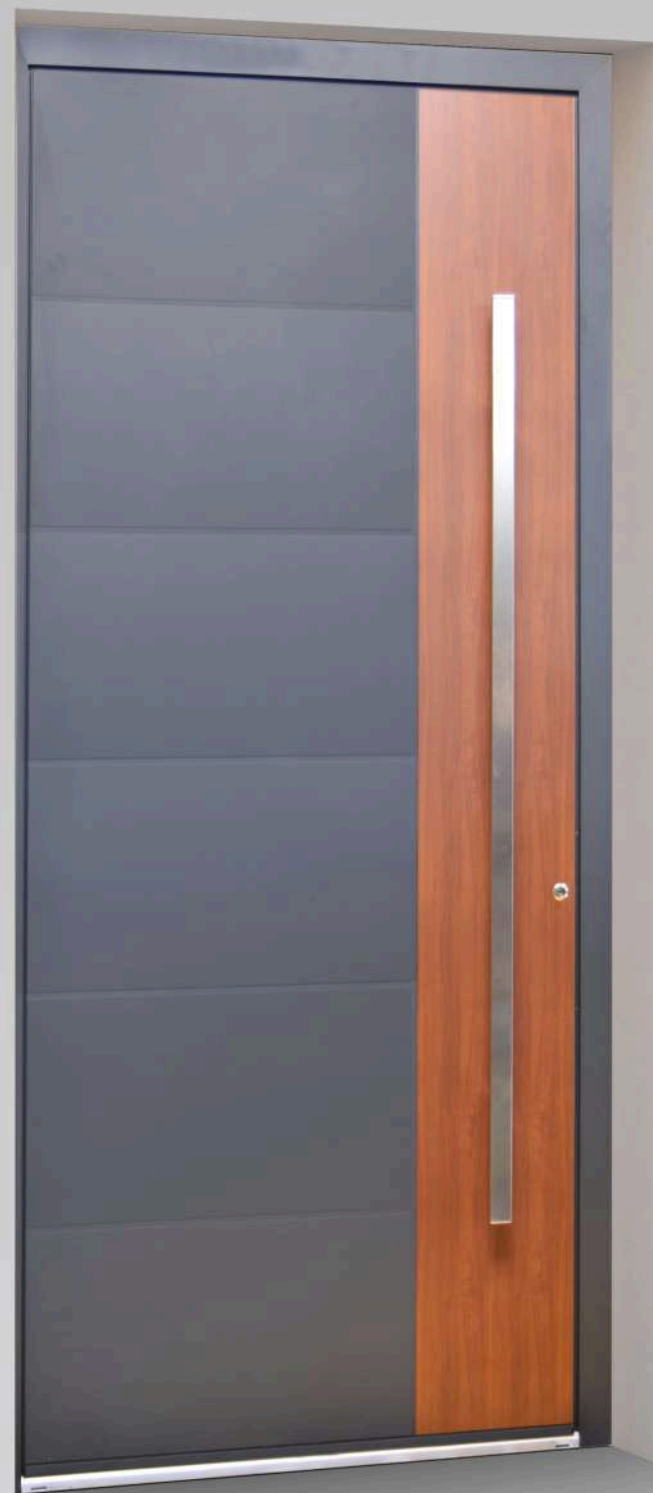

EF 02 KP

KDS 100

FINITURA
7016 R TX / PK A 7

MANIGLIONE
MSX E12 J05

LAVORAZIONE
PANTOGRAFATO FRESATO (11mm)



EF 01 KP

KDS 100

FINITURA

9007 R TX / PK A 3

MANIGLIONE

MSX E73 J02

CON LETTORE BIOMETRICO INTEGRATO



TIPOLOGIA COMPOSTA EF 10 KP
FIANCOLUCE DX + SOPRALUCE

KDS 100

FINITURA
7035 R TX / 7037 R TX

INSERTO
INOX SATINATO (10mm)

MANIGLIONE
MSX E10 J05

VETRO
(J22) (DECORATO)

ACCESSORI
LETTORE BIOMETRICO



EF 03 KP

KDS 100

FINITURA
SK, 16 SD
MANIGLIONE
MSX E14 J05

INSERTO
INOX SATINATO



EF 06 KP

KDS 100

FINITURA
7016 R TX / PK MT12

MANIGLIONE INCASSATO
MIX E02 J05



EF 09 KP

KDS 100

FINITURA
1019 R TX / PK A16

MANIGLIONE INCASSATO
MIX E03 J05



EF 11 KP

KDS 100

FINITURA
9005 R TX / PK A16

MANIGLIONE
MSX E34 J05



EF 10 KP

KDS 100

FINITURA

7035 R TX / 7037 R TX

MANIGLIONE

MSX E10 J05

INSERTO

INOX SATINATO (10 MM)

VETRO

J22 (DECORATO)

ACCESSORI

LETTORE BIOMETRICO



EF 18 KP

KDS 100

FINITURA

7006 R TX / 1019 R TX

MANIGLIONE

MSX E38 J02 (L 1600 mm / I 975 mm)

VETRO

J14 SATINATO BRONZO B.E.



EF 12 KP

KDS 100

FINITURA
8019 R TX / 1013 R TX

MANIGLIONE
MSX E12 J05

VETRO
J20 DESIGN FILI B.E.



EF 13 KP

KDS 100

FINITURA
8017 R TX / 1019 R TX

MANIGLIONE
MSX E10 J05

VETRO / GLASS
J14 SATINATO BRONZO B.E.



EF 25 KP

KDS 100

FINITURA
P GRAF

MANIGLIONE

MSX E63 J05 - CON LETTORE
BIOMETRICO INTEGRATO

INSERTO

INOX SATINATO



EF 26 KP

KDS 100

FINITURA
7035 RTX / 9006 RTX

MANIGLIONE

MSX E03 J05

LAVORAZIONE

PANTOGRAFATO FRESATO (6mm)



EF 27 KP

KDS 100

FINITURA
1019 RTX (MONOCOLORE)

MANIGLIONE INCASSATO
MIX E06 A COLORE

LAVORAZIONE
PANTOGRAFATO PALLA



EF 28 KP

KDS 100

FINITURA
SK 15 SD

MANIGLIONE
MSX E12 J05

INSERTO
INOX SATINATO



EF 29 KP

KDS 100

FINITURA
SK 14 SD R TX / PK A70

MANIGLIONE INCASSATO
MIX E06 IN TINTA RAL



EF 30 KP

KDS 100

FINITURA

SK 13 SD R TX / PK RL3

MANIGLIONE

MSX E63 J05 - CON LETTORE
BIOMETRICO INTEGRATO

LAVORAZIONE

PANTOGRAFATO INCLINATO



EF 31 KP

KDS 100

FINITURA

9006 RTX (MONOCOLORE)

MANIGLIONE

MSX E40 J02

LAVORAZIONE

PANTOGRAFATO FRESATO (6MM)

LINEA **FORM**

Gli inserti a listelli dialogano con le superfici circostanti creando contrasti di forte impatto visivo. I ritmi verticali e orizzontali, l'alternanza tra pieni e vuoti e l'integrazione pulita degli elementi funzionali trasformano la porta in un vero elemento architettonico.





FO 01 KP KDS100

FINITURA
7039 R TX

MANIGLIONE INCASSATO
MIX EO5 IN TINTA RAL

PROFILO ALLUMINIO APPLICATO
35 x 35 MM | PK T2



FO 02 KP KDS100

FINITURA
PK A70

MANIGLIONE
MSX E23 JO5

PROFILO ALLUMINIO APPLICATO
35 x 35 MM | PK A70



FO 03 KP

KDS 100

FINITURA
9005 R TX

MANIGLIONE INCASSATO

MIX E07 IN TINTA RAL

PROFILO ALLUMINIO APPLICATO

35 x 35 MM | 9005 R TX

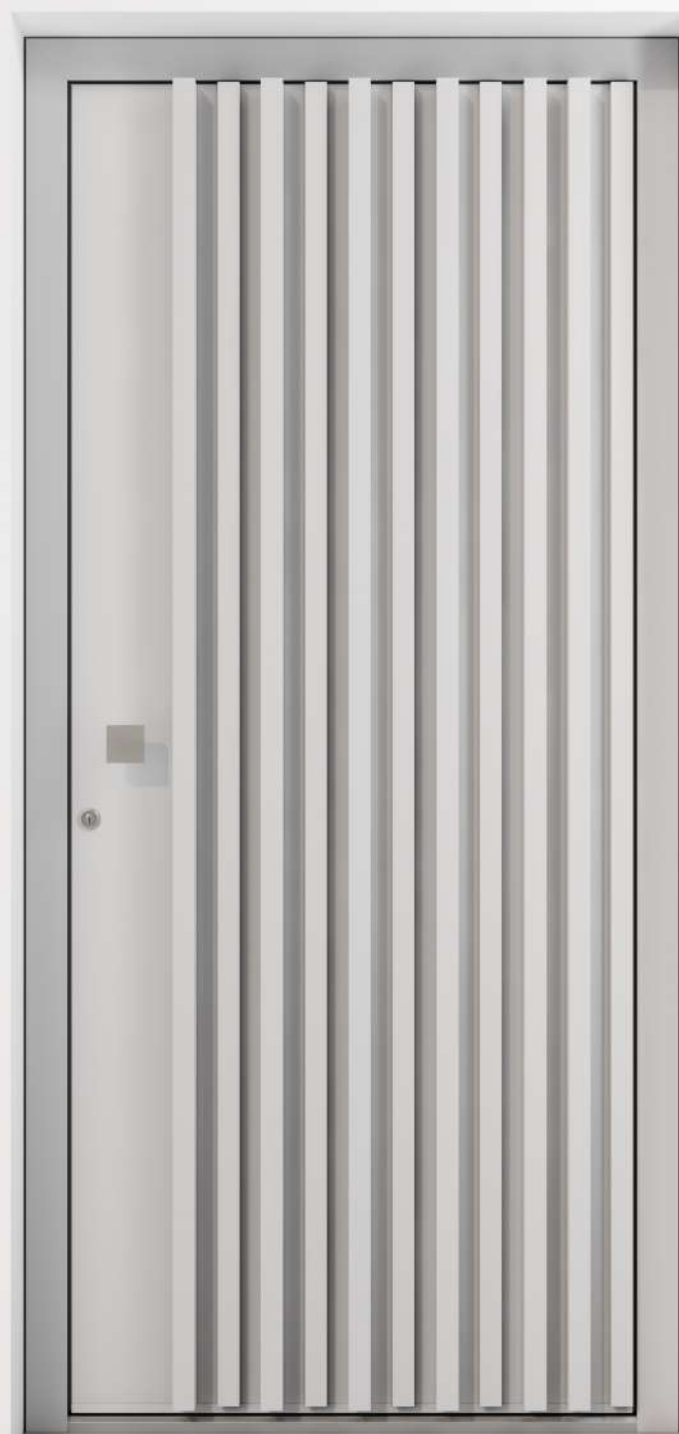

FO 04 KP

KDS 100

FINITURA
7035 R TX

MANIGLIONE
POM E05 JO1

PROFILO ALLUMINIO APPLICATO

35 x 35 + 35 x 60 MM | 7035 R TX



FO 05 KP

KDS 100

FINITURA
P GRAF

MANIGLIONE
MSX E12 J05

PROFILO ALLUMINIO APPLICATO
35 x 60 MM | 7035 R TX
CON LED OPZIONALE

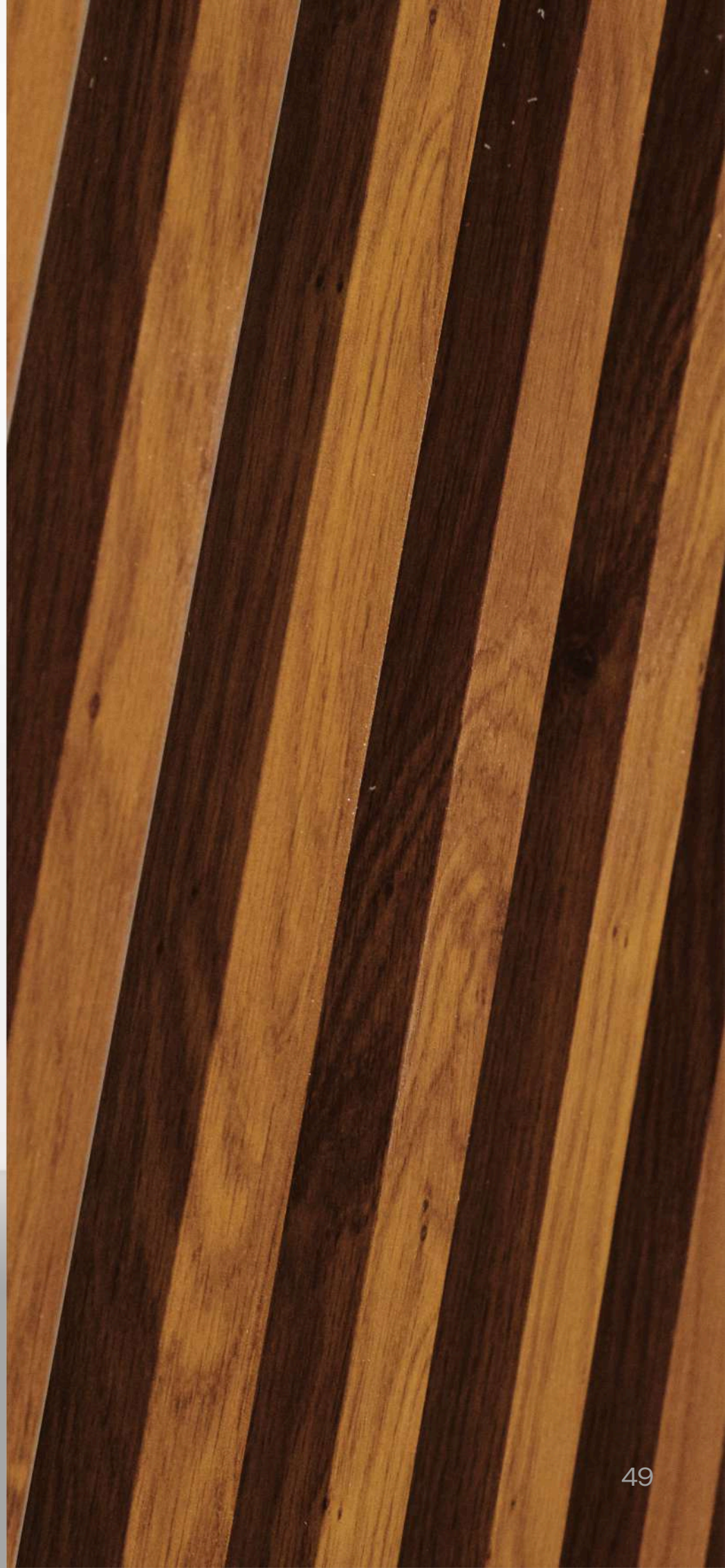

LINEA **MATERIKA**

L'esclusivo design si esprime attraverso tagli geometrici decisi e composizioni asimmetriche, dove l'alluminio incontra texture sofisticate creando giochi di luce e contrasti cromatici che catturano lo sguardo fin dal primo istante.





MT 02 KP

KDS 100

FINITURA
9005 R TX

MANIGLIONE
MSX E23 J05

ANIMA
J33P | VERTO FUME' + ALLUMINIO
DISEGNATO



MT 05 KP

KDS 100

FINITURA
P BEIGE SD

MANIGLIONE INCASSATO

ANIMA
PK A70 | ALLUMINIO



MT 03 KP KDS 100

FINITURA
7006 R TX

MANIGLIONE INCASSATO

ANIMA
J27L | VETRO ANTELIO

INSERTO
BRONZO SATINATO (10 MM)



MT 01 KP KDS 100

FINITURA
P GRAF

MANIGLIONE INCASSATO

ANIMA
LO1 | LASTRA CERAMICA FINITURA
BIANCO STATUARIO VENATO LAMINAM
SUPERIOR NATURAL SURFACES

INSERTO
INOX SATINATO (10 MM)



MT 04 KP KDS 100

FINITURA
8019 R TX

MANIGLIONE INCASSATO
8019 R TX

ANIMA
PK MT28 | ALLUMINIO

INSERTO
BRONZO ORO (10 MM)



LAMINAM
SUPERIOR NATURAL SURFACES

FINITURE ESTERNE – ALLUMINIO

ALLUMINIO RAL



K78
7016 R TX

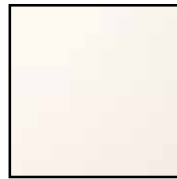

K73
9010 R TX



K79
9005 R TX



K75
9006 R TX

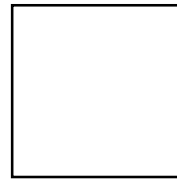

K98
7006 R TX



K93
SK 13 SD



K94
SK 14 SD

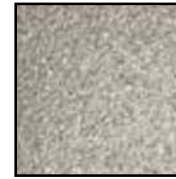

K95
SK 15 SD

FINITURE ANIMA MATERIKA

FINITURE EFFETTO LEGNO/METALLIKA



T12
PK MT21*



T15
PK MT22*



T13
PK MT23*



T16
PK MT24*



T14
PK MT28*



Y83
PK A70*



K47
PK A18*



Y16
PK RL4

LAMINAM
SUPERIOR NATURAL SURFACES



L01
BIANCO
STATUARIO
VENATO



L02
ANKARA



L03
PIETRA GREY



L04
VULCANO



L05
TRAVERTINO
BIANCO
BOCCIARDATO



L06
FOKOS TERRA



L07
PIETRA PIASENTINA
TOUPE FIAMMATO



L08
BRUNO

FINITURE ANIMA MATERIKA

VETRI



J22L

SAT BIANCO +
LAMIERA
LISCIA



J14L

SAT BRONZO +
LAMIERA LISCIA

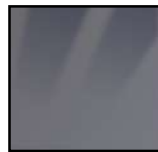

J15L

SAT FUME +
LAMIERA LISCIA



J27L

RIFLETTENTE
ANTELIO +
LAMIERA LISCIA



J33P

TRASP GRIGIO+
LAM
SERIGRAFATA
PALLA



J34P

TRASP BRONZO+
LAM SERIGRAFATA
PALLA



J33I

TRASP GRIGIO+
LAM SERIGRAFATA
INCISA



J34I

TRASP BRONZO+
LAM SERIGRAFATA
INCISA

ALLUMINIO SERIGRAFATO INSERTO**



ALLUMINIO**

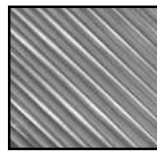

STP

OX ARGENTO +
LAM SERIGRAFATA
PALLA

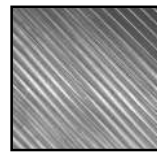

STI

OX ARGENTO +
LAM SERIGRAFATA
INCISA

*Realizzate con polveri, pellicole e inchiostri sublimatici in classe 2 che garantiscono resistenza e alta durabilità nel tempo.

**Disponibile in tinta con la struttura.

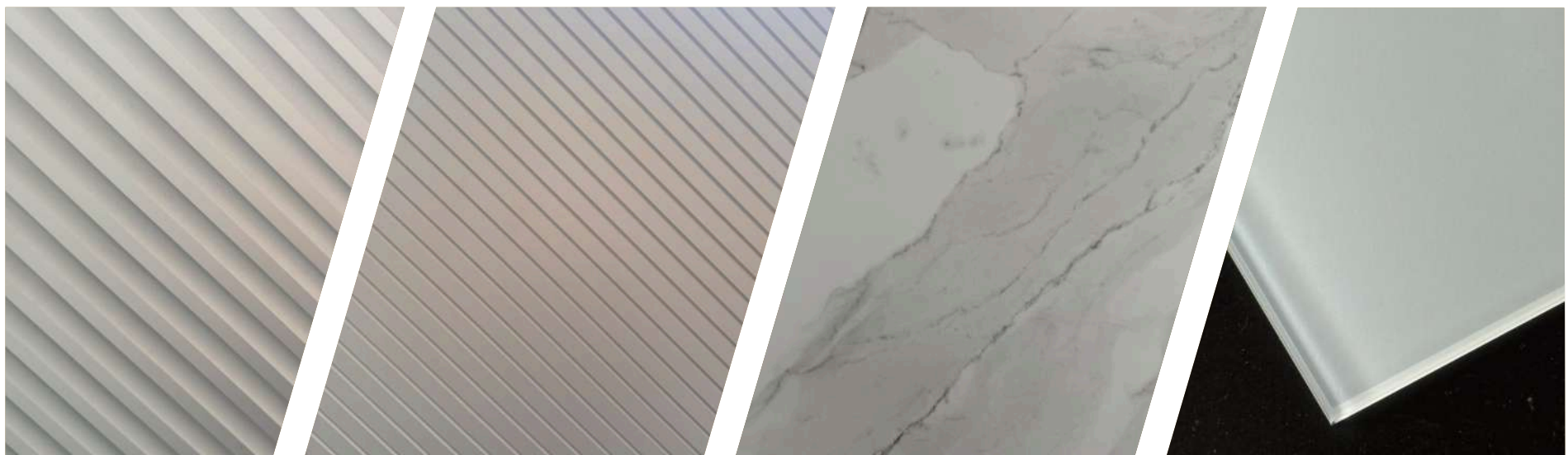

LINEA **VITRUM**

La linea Vitrum di Kopen presenta una selezione di modelli di design con il vetro che diventa assoluto protagonista dello stile architettonico, conferendo alle porte Kopen un alto grado di raffinatezza sia sotto il profilo sensoriale che della diffusione luminosa negli ambienti.

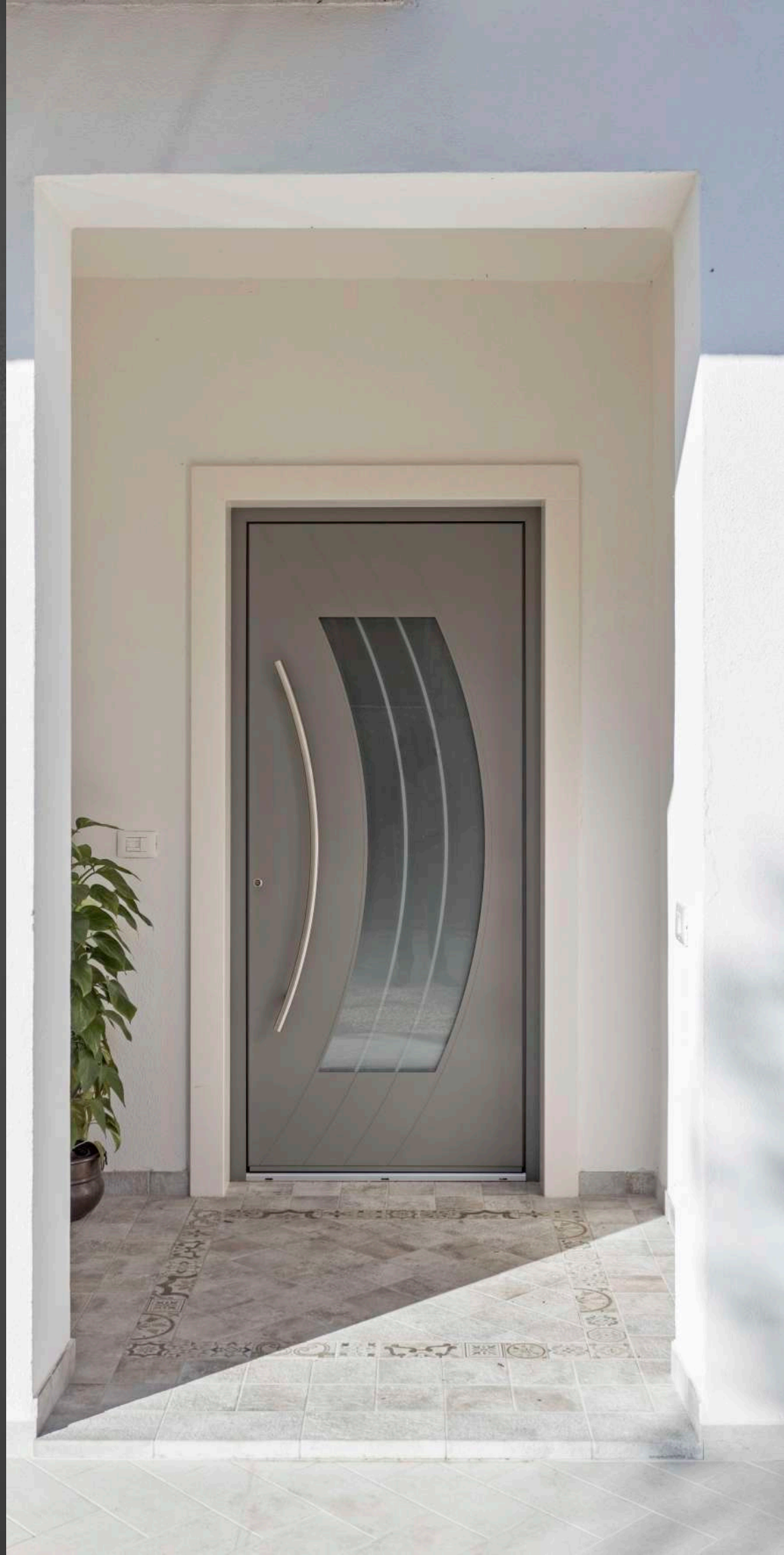



VI 24 KP

KDS 90
KDS 100

FINITURA
1019 R TX

MANIGLIONE
MIX E10 IN TINTA RAL

VETRO
J27 RIFLETTENTE ANTELIO CHIARO B.E.

INSERTO
INOX SATINATO (10 MM)



VI 28 KP

KDS 90
KDS 100

FINITURA
9006 R TX

MANIGLIONE
MSX E39 J05

VETRO
SATINATO BIANCO B.E.

INSERTO
INOX SATINATO (20 MM)



VI 32 KP

KDS 90
KDS 100

FINITURA
P GRAF

MANIGLIONE
MSX E12 J05

VETRO
J15 SATINATO FUME' B.E.

INSERTO
INOX SATINATO



VI 27 KP KDS 90 KDS 100

FINITURA
SK 16 SD

MANIGLIONE
MSX E14 J05

VETRO
J14 SATINATO BRONZO B.E.

INSERTO
INOX SATINATO

LAVORAZIONE
PANTOGRAFATO FRESATO (11MM)



VI 25 KP KDS 90 KDS 100

FINITURA
9002 R TX

MANIGLIONE
MSX E23 J02 (L 400 / | 375 MM)

VETRO
J22 SATINATO BIANCO B.E.

LAVORAZIONE
PANTOGRAFATO FRESATO (11/21/61MM)



VI 29 KP KDS 90 KDS 100

FINITURA
7006 R TX

MANIGLIONE
MSX E23 J02 (L 500 MM / | 475 MM)

VETRO
J14 SATINATO BRONZO B.E.

LAVORAZIONE
PANTOGRAFATO FRESATO (11MM)



VI 30 KP

FINITURA

SK 13 SD

MANIGLIONE INCASSATO

MIX EO7 IN TINTA RAL

VETRO

J14 SATINATO BRONZO B.E.

LAVORAZIONE

PANTOGRAFATO FRESATO (11MM)



VI 31 KP

FINITURA

7035 R TX

MANIGLIONE

MSX E27 JO5

VETRO

J22 SATINATO BIANCO B.E.

INSERTO

INOX SATINATO



VI 26 KP

FINITURA

1019 R TX

MANIGLIONE

MSX E23 JO2 (L 1600 MM / I 575 MM)

VETRO

J14 SATINATO BRONZO B.E. DECORATO

INSERTO

NERO OPACO (10 MM)

LAVORAZIONE

PANTOGRAFATO PALLA



VI 07 KP

KDS 90
KDS 100

FINITURA
9006 R TX

POMOLO
POM E05 J01

VETRO
J15 SATINATO FUME' B.E.

ACCESSORI
LETTORE BIOMETRICO

LAVORAZIONE
PANTOGRAFATO FRESATO (11MM)



VI 08 KP

KDS 90
KDS 100

FINITURA
7016 R TX

MANIGLIONE
MSX E12 J05

VETRO
J22 SATINATO BIANCO B.E.

ACCESSORI
TASTIERINO NUMERICO

LAVORAZIONE
PANTOGRAFATO FRESATO (11MM)



VI 11 KP

KDS 90
KDS 100

FINITURA
3003 R TX

MANIGLIONE
MSX E13 J05

INSERTO
J22 SATINATO BIANCO B.E.

LAVORAZIONE
PANTOGRAFATO FRESATO (11MM)



VI 12 KP

KDS 90
KDS 100

FINITURA

1019 R TX

MANIGLIONE

MSX E14 J05

VETRO

J14 SATINATO BRONZO B.E.

LAVORAZIONE

PANTOGRAFATO FRESATO (11MM)



VI 12 KP

2 ANTE SIMMETRICHE (ANTA SECONDARIA VETRATA)

KDS 90
KDS 100

FINITURA

SK 16 SD

MANIGLIONE

MSX E39 J05

VETRO

J14 SATINATO BRONZO B.E.

LAVORAZIONE

PANTOGRAFATO FRESATO (11MM)



VI 13 KP

KDS 90
KDS 100

FINITURA
9016 R TX
MANIGLIONE
MSX E13 J05
VETRO
J22 SATINATO BIANCO B.E.

LAVORAZIONE
PANTOGRAFATO FRESATO (11MM)



VI 04 KP

KDS 90
KDS 100

FINITURA
7006 R TX
MANIGLIONE
MSX E12 J05
VETRO
J22 SATINATO BIANCO B.E.

LAVORAZIONE
PANTOGRAFATO FRESATO (11MM)



VI 14 KP

KDS 90
KDS 100

FINITURA
6021 R TX
MANIGLIONE
MSX E44 J05
ACCESSORI
TASTIERINO NUMERICO

VETRO
J22

LAVORAZIONE
PANTOGRAFATO FRESATO (11MM)



VI 18 KP

2 ANTE ASIMMETRICHE (ANTA SECONDARIA VETRATA)

KDS 90
KDS 100

FINITURA

9007 R TX

POMOLO

POM E01 J01

VETRO

J22 SATINATO BIANCO B.E.



VI 18 KP

KDS 90
KDS 100

FINITURA

6005 R TX

MANIGLIONE

MSX E12 J05

VETRO

J22 SATINATO BIANCO B.E.



VI 19 KP

KDS 90
KDS 100

FINITURA

PK A18

MANIGLIONE

MSX E13 J05

VETRO

J22 SATINATO BIANCO B.E.



VI 06 KP

KDS 90
KDS 100

FINITURA

9007 R TX

MANIGLIONE

MSX E40 J02

ACCESSORI

LETTORE BIOMETRICO

VETRO

J22 SATINATO BIANCO B.E.

LAVORAZIONE

PANTOGRAFATO FRESATO (11MM)



VI 15 KP

KDS 90
KDS 100

FINITURA

7037 R TX

MANIGLIONE

MSX E23 J05 TUTTA LARGHEZZA

VETRO

J22 SATINATO BIANCO B.E.

LAVORAZIONE

PANTOGRAFATO FRESATO (11MM)



VI 05 KP

KDS 90
KDS 100

FINITURA
PK A3

MANIGLIONE
MSX E04 J05

VETRO
J22 BIANCO SATINATO B.E.

INSERTO
INOX SATINATO (10MM)



VI 03 KP

KDS 90
KDS 100

FINITURA
7016 R TX

MANIGLIONE
MSX E14 J05

VETRO
J22 SATINATO BIANCO B.E.



VI 21 KP

KDS 90
KDS 100

FINITURA

PK A18

POMOLO

POM E02 J01

INSERTO

INOX SATINATO (30MM)

VETRO

(J22) SATINATO BIANCO B.E.



VI 16 KP

KDS 90
KDS 100

FINITURA

9006 R TX

MANIGLIONE

MSX E44 J05

VETRO

J22 (DECORATO)

LAVORAZIONE

PANTOGRAFATO FRESATO (11MM)



VI 17 KP

KDS 90
KDS 100

FINITURA
9006 R TX

MANIGLIONE
MSX E12 J05

INSERTO
J22 SATINATO BIANCO B.E. DECORATO

LAVORAZIONE
PANTOGRAFATO FRESATO (11MM)



VI 02 KP

KDS 90
KDS 100

FINITURA
8017 R TX

MANIGLIONE
MSX E01 J05

VETRO
(J22) SATINATO BIANCO B.E.

LAVORAZIONE
PANTOGRAFATO FRESATO (11MM)



VI 01 KP

KDS 90
KDS 100

FINITURA
PK A7

MANIGLIONE
MSX E14 J05

VETRO
J22 SATINATO BIANCO B.E.

LINEA **LUMIERE**

Lumiere è l'innovativo portoncino con anta vetrata, progettato per trasformare l'ingresso in uno spazio elegante e luminoso. La trasparenza del vetro diventa protagonista assoluta, permettendo alla luce di fluire liberamente negli ambienti e creando una continuità visiva tra interno ed esterno.





**TIPOLOGIA COMPOSTA
LU 01 KP + FIANCOLUCE DX**

KDS 100

FINITURA
7001 R TX

MANIGLIONE
MSX E06 J05

VETRO
J22 SATINATO BIANCO B.E.



**LU 01 KP
2 ANTE ASIMMETRICHE**

KDS 100

FINITURA
9006 R TX

POMOLO
POM E01 J01

VETRO
J22 SATINATO BIANCO B.E.



LU 01 KP

KDS 90

BILICO/PIVOT

FINITURA
9005 R TX

VETRO
(J22) SATINATO BIANCO B.E.



LU 01 KP

KDS 90

FINITURA
PK A3

MANIGLIONE
TUTTA ALTEZZA
MSX E26 J02

VETRO
J15 SATINATO FUME' B.E.

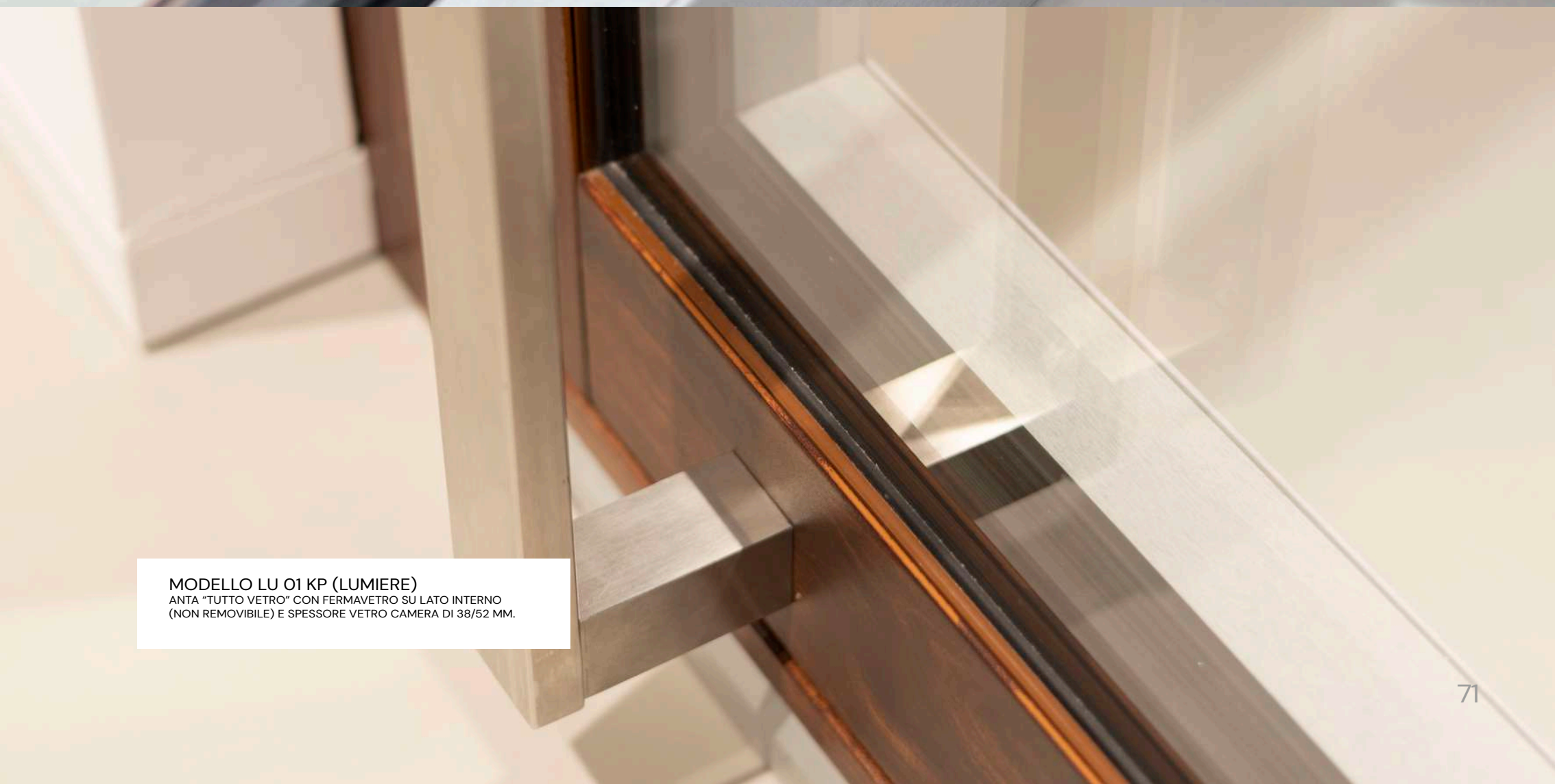

MODELLO LU 01 KP (LUMIERE)
ANTA "TUTTO VETRO" CON FERMAVETRO SU LATO INTERNO
(NON REMOVIBILE) E SPESSORE VETRO CAMERA DI 38/52 MM.

LINEA STYLE

Il design delle porte della linea Style di Kopen offre una selezione di modelli con schemi di partizione regolari, valorizzati da raffinati inserti in alluminio. Ciò rende ogni porta una proposta attuale e poliedrica, in cui l'uso sapiente dell'accessorio e della finitura ne consentono l'integrazione con ogni stile architettonico.





ST 01 KP

KDS 90
KDS 100

FINITURA

7016 R TX

MANIGLIONE

MSX E13 J05

INSERTO

INOX SATINATO (10MM)

ACCESSORI

TASTIERINO NUMERICO



ST 02 KP

KDS 90
KDS 100

FINITURA

7001 RTX

MANIGLIONE

MSX E14 J05

INSERTO

INOX SATINATO (10/60 MM)



ST 09 KP

KDS 90
KDS 100

FINITURA

PK A 3

MANIGLIONE

MSX E63 J02 - CON LETTORE BIOMETRICO INTEGRATO

INSERTO

NERO OPACO (20/60 MM)

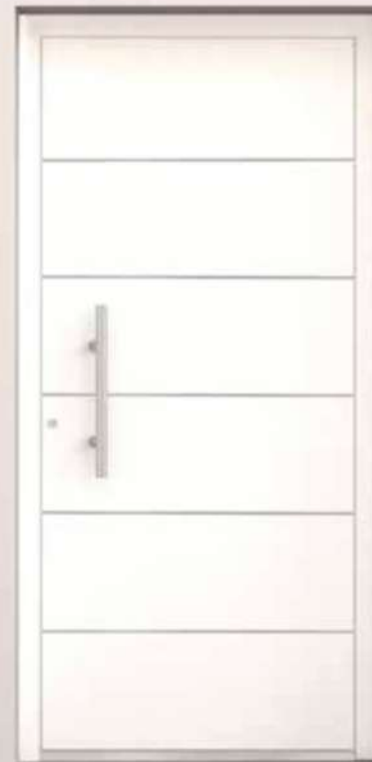

ST 10 KP

KDS 90
KDS 100

FINITURA
9016 RTX

MANIGLIONE
MSX EO4 JO5

INSERTO
INOX SATINATO (10 MM)



ST 05 KP

KDS 90
KDS 100

FINITURA
8014 RTX

MANIGLIONE INCASSATO
MIX EO2 JO5

INSERTO
INOX SATINATO (10 MM)

ACCESSORI
SPIONCINO



ST 07 KP

KDS 90
KDS 100

FINITURA
9006 RTX

MANIGLIONE
MSX E13 J05

INSERTO
INOX SATINATO (10 MM)

ACCESSORI
LETTORE BIOMETRICO

LAVORAZIONE
PANTOGRAFATO FRESATO (11MM)



ST 04 KP

KDS 90
KDS 100

FINITURA
PK MT12

MANIGLIONE
MSX E12 J05

INSERTO
INOX SATINATO (10 MM)



ST 04 KP

KDS 100

2 ANTE ASIMMETRICHE

FINITURA
7016 R TX

MANIGLIONE
MSX E13 J05

INSERTO
INOX SATINATO (10MM)



ST 08 KP



FINITURA
7037 RTX

MANIGLIONE
MSX E12 J05

INSERTO
INOX SATINATO (10MM)

LAVORAZIONE
PANTOGRAFATO FRESATO (11MM)

INSERTI

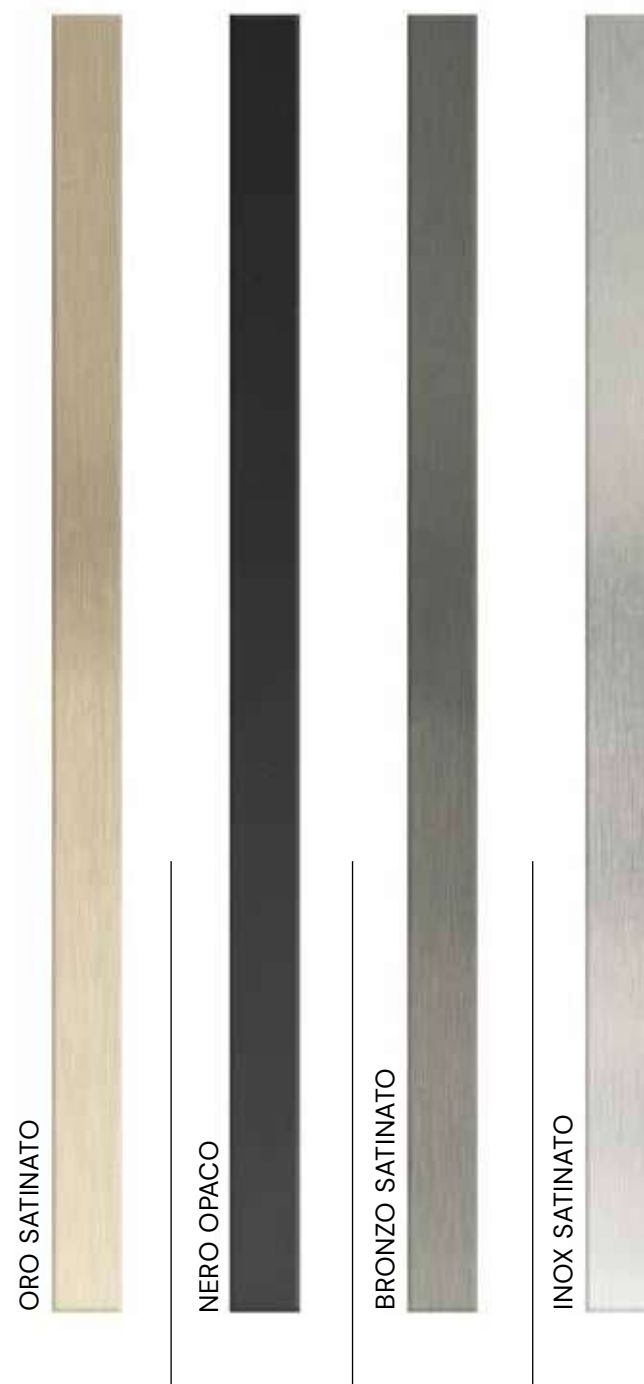

ORO SATINATO

NERO OPACO

BRONZO SATINATO

INOX SATINATO

DIMENSIONI

10 mm	10 mm	10 mm	10 mm
	20 mm		20 mm
	60 mm		60 mm



ST 12 KP

KDS 90
KDS 100

FINITURA

SK 16 SD

MANIGLIONE INCASSATO

MIX E05 A COLORE IN TINTA RAL

INSERTO

OX SATINATO (20 MM)



ST 11 KP

KDS 90
KDS 100

FINITURA

5014 RTX

MANIGLIONE

MSX E64 J05 - CON LETTORE BIOMETRICO INTEGRATO

INSERTO

INOX SATINATO (10/60 MM)



ST 13 KP 

FINITURA
P GRAF

MANIGLIONE INCASSATO
MIX E05 IN TINTA RAL

INSERTO
NERO OPACO (20 MM)



ST 14 KP 

FINITURA
7006 R TX

MANIGLIONE INCASSATO
MIX E10 IN TINTA RAL

INSERTO
BRONZO SATINATO (10 MM)



ST 15 KP



FINITURA
P BEIGE SD

MANIGLIONE
MSX E27

INSERTO
INOX SATINATO (10/20/60 MM)

LAVORAZIONE
PANTOGRAFATO FRESATO (10/20/60MM)

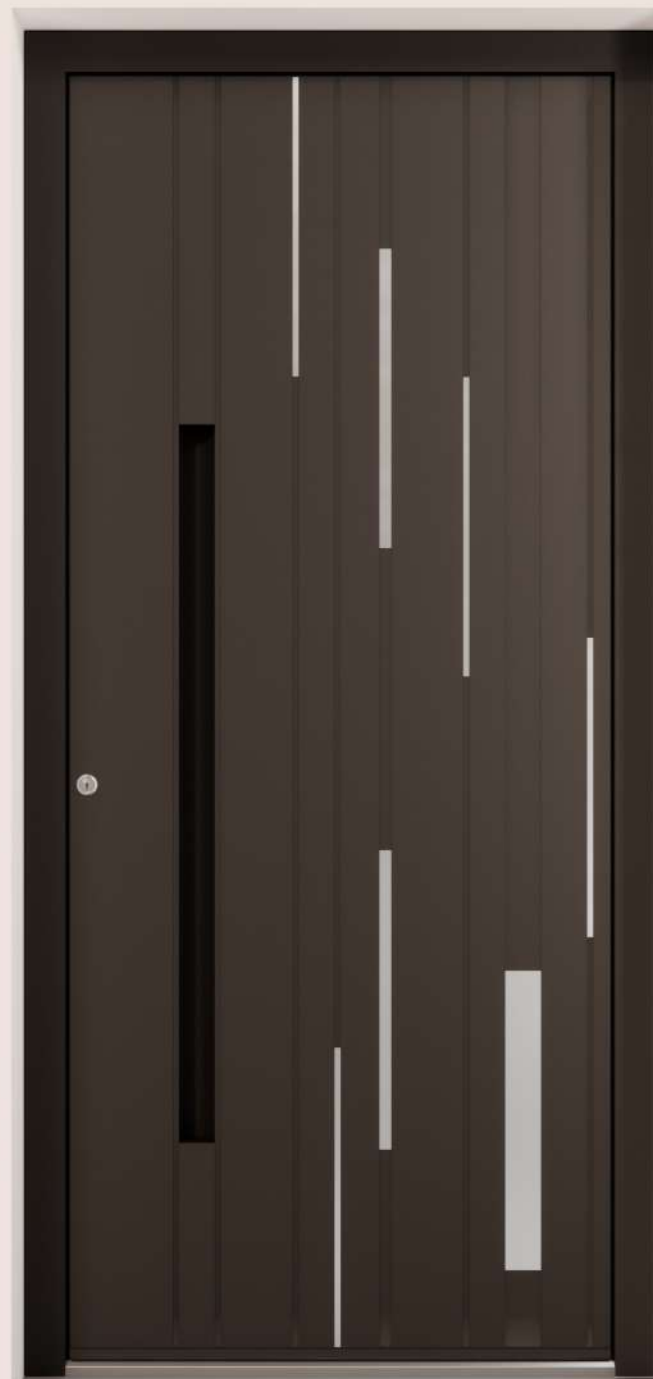

ST 17 KP



FINITURA
8019 R TX

MANIGLIONE INCASSATO
MIX E08 IN TINTA RAL

INSERTO
INOX SATINATO (10/20/60 MM)

LAVORAZIONE
PANTOGRAFATO FRESATO (10/20/60MM)

LINEA **PURE**

Partiture geometriche definite da sottili fresature o incisioni, forme artistiche originali e suddivisioni modulari. La ricerca di particolari di design confluisce nel carattere minimal ed elegante delle porte della linea Pure di Kopen.





PU 26 KP KDS 90
KDS 100

FINITURA
1013 R TX

MANIGLIONE
MSX E13 J05

LAVORAZIONE
PANTOGRAFATO FRESATO (11 MM)



PU 27 KP KDS 90
KDS 100

FINITURA
7001 R TX

MANIGLIONE INCASSATO
MIX E05 IN TINTA RAL

LAVORAZIONE
PANTOGRAFATO FRESATO (11 MM)



PU 02 KP

KDS 90
KDS 100

FINITURA
9007 R TX

MANIGLIONE
MSX E03 J05

LAVORAZIONE
PANTOGRAFATO FRESATO (11 MM)



PU 01 KP

KDS 90
KDS 100

FINITURA
7016 R TX
MANIGLIONE
MSX E12 J05



PU 03 KP

KDS 90
KDS 100

FINITURA
SK 16 SD

MANIGLIONE
TUTTA ALTEZZA
MSX E23 J05

LAVORAZIONE
PANTOGRAFATO FRESATO (11 MM)



PU 04 KP



FINITURA
7035 R TX

MANIGLIONE
MSX E14 J05

LAVORAZIONE
PANTOGRAFATO FRESATO (11 MM)



PU 08 KP



FINITURA
8017 R TX

MANIGLIONE
MSX E40 J02

ACCESSORI
LETTORE BIOMETRICO

LAVORAZIONE
PANTOGRAFATO FRESATO (11 MM)



PU 09 KP



FINITURA
7016 R TX

MANIGLIONE
MSX E26 J05 (L 500 MM / I 470 MM)

LAVORAZIONE
PANTOGRAFATO FRESATO (11 MM)



PU 14 KP

KDS 90
KDS 100

FINITURA

SK 16 SD

MANIGLIONE

MSX E12 J05

LAVORAZIONE

PANTOGRAFATO FRESATO (11 MM)



PU 16 KP

KDS 90
KDS 100

FINITURA

7001 R TX

MANIGLIONE

MSX E13 J05

ACCESSORI

LETTORE BIOMETRICO

LAVORAZIONE

PANTOGRAFATO FRESATO (11MM)



PU 12 KP

KDS 90
KDS 100

FINITURA

7001 R TX

MANIGLIONE

MSX E13 J05

LAVORAZIONE

PANTOGRAFATO FRESATO (11 MM)



PU 17 KP

KDS 90
KDS 100

FINITURA
7037 R TX

MANIGLIONE
MSX E12 J05

LAVORAZIONE
PANTOGRAFATO FRESATO (11 MM)



PU 15 KP

KDS 90
KDS 100

FINITURA
7016 R TX

MANIGLIONE
MSX E12 J05

LAVORAZIONE
PANTOGRAFATO FRESATO (11 MM)



PU 02 KP
2 ANTE ASIMMETRICHE

KDS 100

FINITURA
9007 R TX

MANIGLIONE
MSX E04 J05

LAVORAZIONE
PANTOGRAFATO FRESATO (11 MM)



PU 03 KP
2 ANTE ASIMMETRICHE (ANTA SECONDARIA VETRATA)

KDS 100

POMOLO
POM E01 J01

VETRO
J22 SATINATO BIANCO B.E.

ACCESSORI
SPI K01 J11 SPIONCINO

LAVORAZIONE
PANTOGRAFATO FRESATO (11 MM)



PU 18 KP



FINITURA
7037 R TX

MANIGLIONE
MSX E39 J05

LAVORAZIONE
PANTOGRAFATO FRESATO (11 MM)

FRESATURA (11 MM)

PER FINITURE RAL TEXTURIZZATE ED EFFETTO LEGNO RELIF

INCISIONE (3 MM)

PER FINITURE RAL TEXTURIZZATE, EFFETTO LEGNO RELIF E EFFETTO
LEGNO/METALLIKA SUBLIMATO



PU 20 KP

KDS 90
KDS 100

FINITURA

PK A16

MANIGLIONE

MSX E13 J05

LAVORAZIONE

PANTOGRAFATO INCISO (3 MM)



PU 21 KP

KDS 90
KDS 100

FINITURA

PK T2

MANIGLIONE

MSX E03 J05

LAVORAZIONE

PANTOGRAFATO INCISO (3 MM)



PU 25 KP

KDS 90
KDS 100

FINITURA
PK A7

MANIGLIONE
MSX E03 J05

LAVORAZIONE
PANTOGRAFATO INCISO (3 MM)



PU 23 KP

KDS 90
KDS 100

FINITURA
9006 R TX

MANIGLIONE
MSX E14 J05

ACCESSORI
SPI KO1 J11 SPIONICO

LAVORAZIONE
PANTOGRAFATO INCISO (3 MM)



PU 24 KP

KDS 90
KDS 100

FINITURA
1019 R TX

MANIGLIONE
MSX E26 J05 (L 500 MM / I 470 MM)

LAVORAZIONE
PANTOGRAFATO INCISO (3 MM)

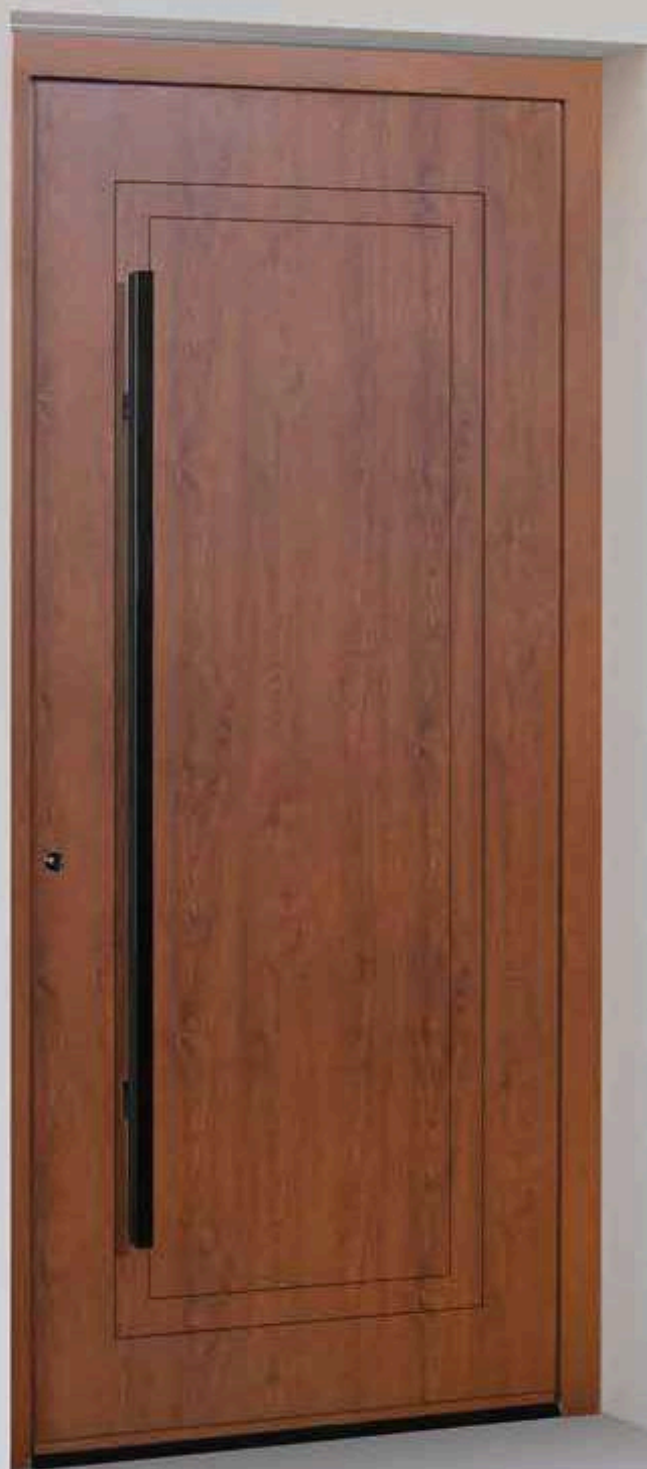

DETTAGLIO CON LAVORAZIONE A INCISIONE



PU 22 KP KDS 90
KDS 100

FINITURA
PK A7

MANIGLIONE
MSX E74 J02

ACCESSORI
LETTORE BIOMETRICO

LAVORAZIONE
PANTOGRAFATO INCISO (3 MM)



PU 29 KP



FINITURA
7037 R TX

MANIGLIONE
MSX E12 J05

LAVORAZIONE
PANTOGRAFATO FRESATO (11 MM)



PU 30 KP



FINITURA
1019 R TX

MANIGLIONE
MSX E27 J05

LAVORAZIONE
PANTOGRAFATO FRESATO (11 MM)



PU 31 KP



FINITURA
1013 R TX

MANIGLIONE
MSX E74 J05 - CON LETTORE BIOMETRICO

LAVORAZIONE
PANTOGRAFATO FRESATO (11 MM)



PU 32 KP

KDS 90
KDS 100

FINITURA
7037 R TX

MANIGLIONE INCASSATO
MIX E05 IN TILTA RAL / IN RAL COLOR

LAVORAZIONE
PANTOGRAFATO FRESATO (11 MM)



PU 33 KP

KDS 90
KDS 100

FINITURA
7001 R TX

MANIGLIONE INCASSATO
MIX E05 IN TILTA RAL

LAVORAZIONE
PANTOGRAFATO FRESATO (11 MM)



PU 34 KP

KDS 90
KDS 100

FINITURA
SK 15 SD R TX

MANIGLIONE INCASSATO
MIX E05 J02

LAVORAZIONE
PANTOGRAFATO FRESATO (11 MM)



PU 37 KP

KDS 90
KDS 100

FINITURA

7037 R TX

POMOLO

POM E05 J01

LAVORAZIONE

PANTOGRAFATO FRESATO (11 MM)



PU 50 KP

KDS 90
KDS 100

FINITURA

5014 RTX

MANIGLIONE

MSX E64 J05 - CON LETTORE
BIOMETRICO INTEGRATO

LAVARAZIONE

PANTOGRAFATO PALLA

LINEA **CLASSIC**

Una cornice a rilievo conferisce alle porte della linea Classic di Kopen quel carattere di eleganza e ricercatezza che ben si abbinano allo stile classico e senza tempo delle abitazioni tradizionali.





CL 01 KP

KDS 90
KDS 100

FINITURA
8017 R TX
POMOLO
POM E01 J01



CL 06 KP

KDS 90
KDS 100

FINITURA
PK A16
POMOLO GIREVOLE
POM E10 J10





CL 03 KP 

FINITURA
PK A3

POMOLO
POM E01 J01

ACCESSORI
SPI K01 J11 SPIONCINO



CL 05 KP 

FINITURA
PK A7
MANIGLIONE
MSX E28 J10



CL 04 KP 

FINITURA
9006 R TX
POMOLO
POM E01 J01



LINEA **FRAME**

La ricerca della forma artistica delle porte della linea Frame di Kopen nasce dall'analisi dei motivi architettonici delle principali città europee che trovano espressione nel particolare motivo geometrico delle bugnature.





FR 01 KP

KDS 100

FINITURA
3003 R TX

MANIGLIONE
MSX E31 J03

ACCESSORI
BAT E02 J03 BATTENTE



FR 02 KP

KDS 100

FINITURA
SK 16 SD

MANIGLIONE
MSX E03 J05



FR 04 KP

KDS 100

FINITURA
PK A7

MANIGLIONE
MSX E27 J05

ACCESSORI
SPI K01 J11 SPIONCINO



FR 05 KP

KDS 100

FINITURA
9007 R TX

MANIGLIONE
MSX E34 J05

ACCESSORI
SPI K01 J11 SPIONCINO



FR 05 KP

KDS 100

2 ANTE SIMMETRICHE

FINITURA
8014 R TX

POMOLO
POM E02 J11



FR 06 KP

KDS 100

FINITURA
PK A16

POMOLO
POM E02 J11



FR 03 KP

KDS100

FINITURA
9010 R TX

POMOLO
POM E01 J01

ACCESSORI
SPI K01 J11 SPIONCINO



FR 13 KP

KDS100

FINITURA
PK A70

POMOLO
POM E03 J10



FR 11 KP KDS 100

FINITURA
6021 R TX

POMOLO GIREVOLE
POM E10 J10



FR 17 KP KDS 100

FINITURA
7039 R TX

POMOLO
POM E01 J01



FR 14 KP KDS 100

FINITURA
7001 R TX

MANIGLIONE
MSX E23 J02
L=BUGNA (L 500 MM - I 475 MM)



FR 08 KP

KDS 100

FINITURA
PK A7

MANIGLIONE
MSX E29 J11

VETRO
J22 SATINATO BIANCO B.E.



FR 09 KP

KDS 100

FINITURA
7006 R TX

POMOLO
POM E01 J01

VETRO
J14 SATINATO BRONZO B.E.



FR 10 KP

KDS 100

FINITURA
P G MA

MANIGLIONE
MSX E04 J05

VETRO
J22 SATINATO BIANCO B.E.

ACCESSORI
SPI K01 J11 SPIONCINO



FR 15 KP KDS 100

FINITURA
P GRAF

VETRO
J22 SATINATO BIANCO B.E.



FR 16 KP KDS 100

FINITURA
7006 R TX
MANIGLIONE
MSX E34 JO5

VETRO
J22 SATINATO BIANCO B.E.



FR 16 KP

KDS 100

2 ANTE ASIMMETRICHE (ANTA SECONDARIA VETRATA)

FINITURA

PK A 18

VETRO

J22 SATINATO BIANCO B.E.



LINEA **NATURAL**

L'eleganza intramontabile e il calore del legno si combinano con la tecnologia dell'alluminio, per dare origine alle porte della linea Natural di Kopen.





WD 12 KP KDS 100

FINITURA
M27 ROVERE SBIANCATO

MANIGLIONE
MSX E42 J05 (M27)

LEGNO MASSELLO
SPESSORE 20MM



WD 02 KP KDS 100

FINITURA
M07 OKOUME' TINTO NOCE MEDIO

MANIGLIONE
MSX E14 J05



WD 06 KP KDS 100

FINITURA
M03 OKOUME' TINTO CILIEGIO

MANIGLIONE
MIX E02 J05



INSTALLAZIONE
ALL'ESTERNO RIPARATO

WD 01 KP KDS 100

FINITURA
M08 OKOUME' TINTO WENGE'

MANIGLIONE
MSX E38 J02



WD 04 KP KDS 100

FINITURA
M08 OKOUME' TINTO WENGE'

MANIGLIONE
MSX E15 J05



WD 05 KP KDS 100

FINITURA
M02 OKOUME' TINTO SBIANCATO

MANIGLIONE
MSX E01 J05





WD 03 KP KDS 100

FINITURA
M05 OKOUME' TINTO MOGANO CHIARO

MANIGLIONE
MSX E13 JO5



INSTALLAZIONE
ALL'ESTERNO RIPARATO

WD 11 KP KDS 100

FINITURA
M25 NOCE/NERO OPACO/ BIANCO OPACO

MANIGLIONE
MIX E04 JO2 (INSERTO NOCE)

LEGNO MASSELLO
20MM



INSTALLAZIONE
ALL'ESTERNO RIPARATO

WD 13 KP KDS 00

FINITURA
M21 ROVERE NATURALE
ACCIAIO INOX SATINATO

MANIGLIONE
MSX E43 JO5 (M21)

LEGNO MASSELLO
20MM



WD 08 KP KDS 100

FINITURA
M07 OKOUME' TINTO NOCE MEDIO

MANIGLIONE
MSX E28 J10



WD 09 KP KDS 100

FINITURA
M10 OKOUME' LACCATO 1015

POMOLO
POM E03 J10



WD 07 KP KDS 100

FINITURA
M09 OKOUME' VERDE METALLIZZATO

MANIGLIONE
MSX E28 J10



WD 14 KP KDS 100

FINITURA
M04 OKOUME' TINTO ROVERE

POMOLO
POM E03 J10

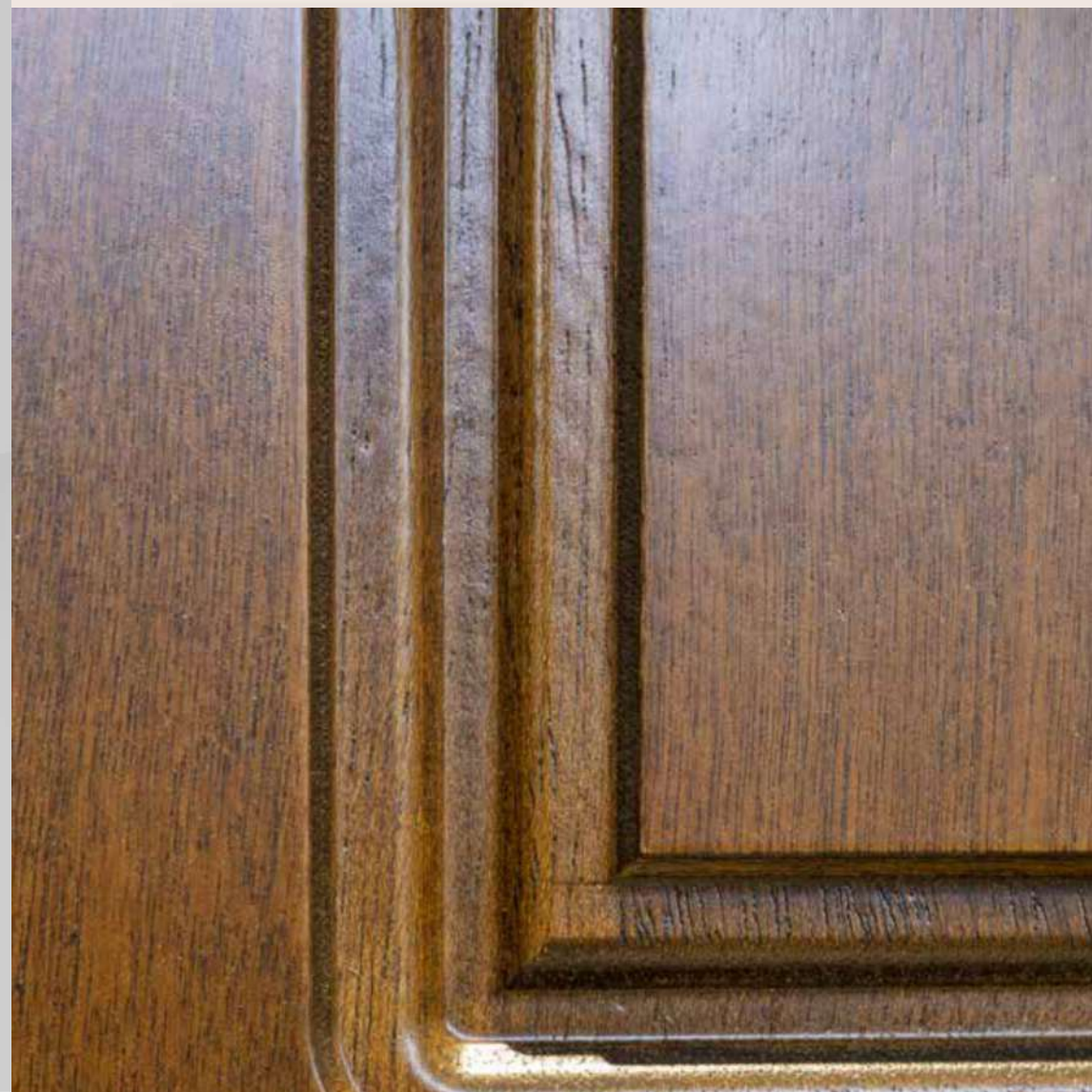



WD 16 KP KDS 100

FINITURA
M03 OKOUME' TINTO CILIEGIO

POMOLO
POM E03 J10



WD 10 KP KDS 100

FINITURA
M04 OKOUME' TINTO ROVERE

MANIGLIONE
MSX E28 J10



WD 15 KP KDS 100

FINITURA
M06 OKOUME' TINTO CASTAGNO

MANIGLIONE
MSX E04 J05

ACCESSORI

KOPEN

Kopen offre un'ampia scelta di accessori di qualità e di design per valorizzare al meglio ogni porta d'ingresso soddisfacendo ogni esigenza di stile e personalità.



MANIGLIONI ESTERNI

TONDO ø30 mm (DRITTO)

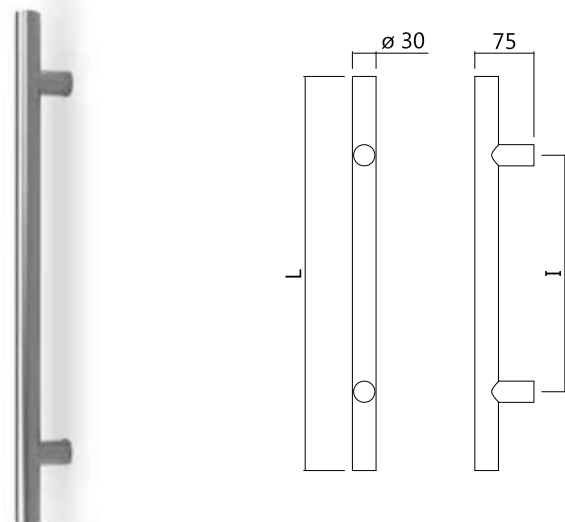

CODICE LUNGHEZZA (mm) INTERASSE (mm)

MSX E01 J05	1600	1200
MSX E02 J05	1200	900
MSX E03 J05	800	560
MSX E04 J05	500	300

■ ACCIAIO INOX SATINATO

TONDO ø30 mm (ZANCATO)

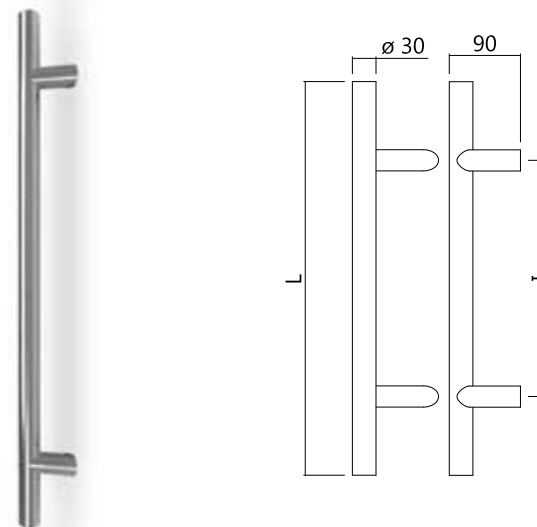

CODICE LUNGHEZZA (mm) INTERASSE (mm)

MSX E05 J05	1600	1200
MSX E06 J05	1200	900
MSX E07 J05	800	560
MSX E08 J05	500	300

■ ACCIAIO INOX SATINATO
(Modelli ZANCATI solo per LINEA LUMIERE LU01KP)

RETTANGOLARE 40x15 mm (DRITTO)

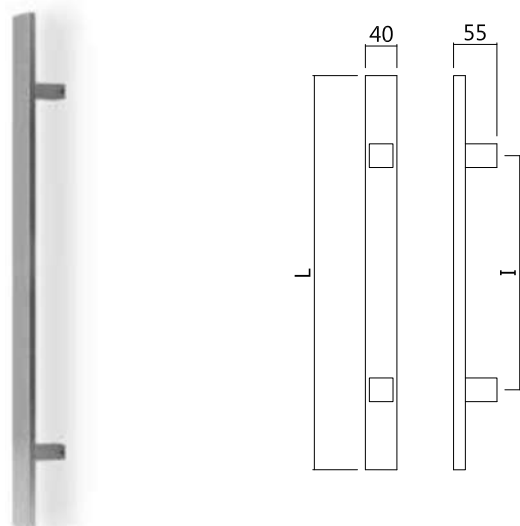

CODICE LUNGHEZZA (mm) INTERASSE (mm)

MSX E12 J05	1600	1200
MSX E13 J05	1200	900
MSX E14 J05	800	560

■ ACCIAIO INOX SATINATO

RETTANGOLARE 40x15 mm (ZANCATO)

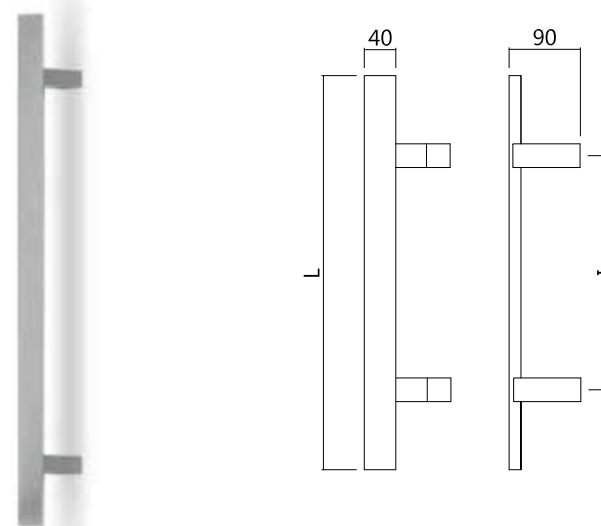

CODICE LUNGHEZZA (mm) INTERASSE (mm)

MSX E15 J05	1600	1200
MSX E16 J05	1200	900
MSX E17 J05	800	560

■ ACCIAIO INOX SATINATO
(Modelli ZANCATI solo per LINEA LUMIERE LU01KP)

MANIGLIONI ESTERNI

TONDO CURVO ø30 mm

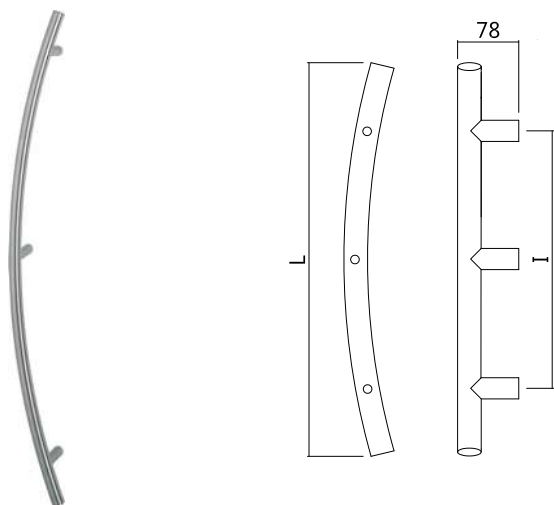

CODICE LUNGHEZZA (mm) INTERASSE (mm)

MSX E44 J05 (3 SUPP)	1200	1000
MSX E11 J05 (2 SUPP)	600	485

■ ACCIAIO INOX SATINATO

QUADRATO 35x35 mm (DRITTO)

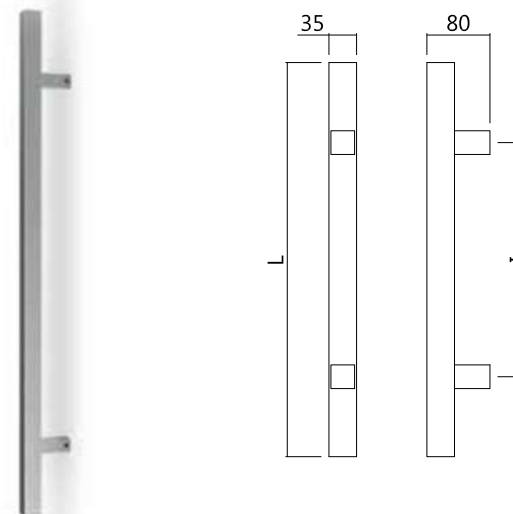

CODICE LUNGHEZZA (mm) INTERASSE (mm)

MSX E18 J05	1600	1200
MSX E19 J05	1200	900
MSX E20 J05	800	560

■ ACCIAIO INOX SATINATO

OVALE 40x20

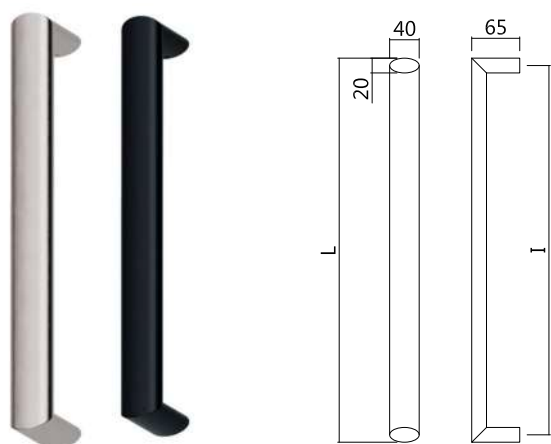

CODICE LUNGHEZZA (mm) INTERASSE (mm)

MSX E33 J05	840	820
MSX E34 J05	370	350

■ ACCIAIO INOX SATINATO

MSX E34 J02	370	350
-------------	-----	-----

■ NERO OPACO

PIATTO 40x7

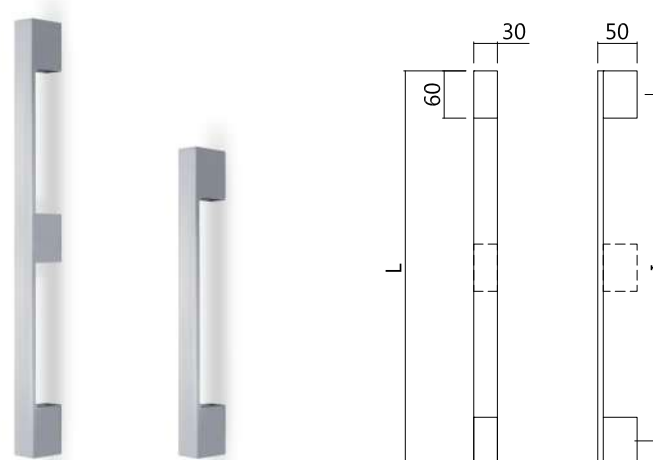

3 SUPPORTI 2 SUPPORTI

CODICE LUNGHEZZA (mm) INTERASSE (mm)

MSX E35 J05	3 SUPPORTI	1600	1540
MSX E36 J05	3 SUPPORTI	1200	1140
MSX E37 J05	2 SUPPORTI	950	890

■ ACCIAIO INOX SATINATO

MANIGLIONI ESTERNI

RETTANGOLARE 30x7 mm (DRITTO DISASSATO)

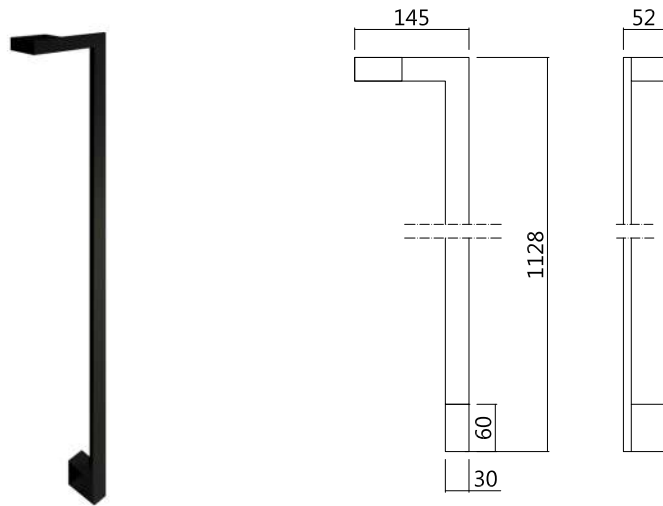

CODICE LUNGHEZZA (mm)

MSX E40 J05	1128
MSX E40 J02	1128

■ ACCIAIO INOX SATINATO

■ NERO OPACO

SUPPORTO ACCIAIO INOX/RIVESTIMENTO LEGNO

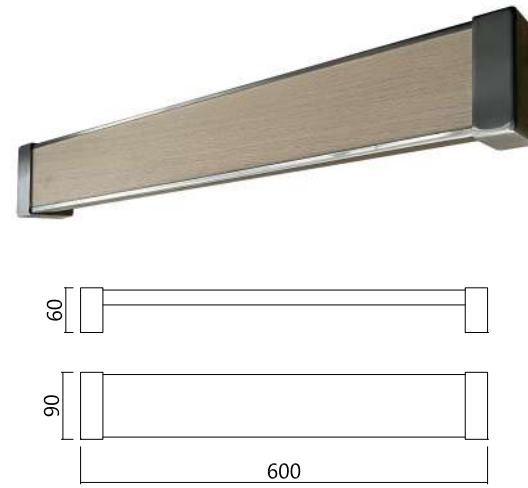

CODICE LUNGHEZZA (mm)

MSX E42 J05	600
--------------------	-----

■ ACCIAIO INOX SATINATO
Rivestimento legno

RETTANGOLARE STONDATO 30x7 mm

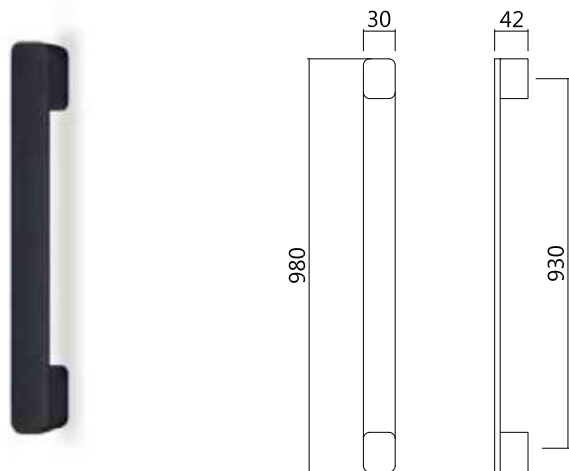

CODICE LUNGHEZZA (mm) INTERASSE (mm)

MSX E38 J02	980 mm	930 mm
-------------	--------	--------

■ NERO OPACO

MANIGLIONI A MISURA

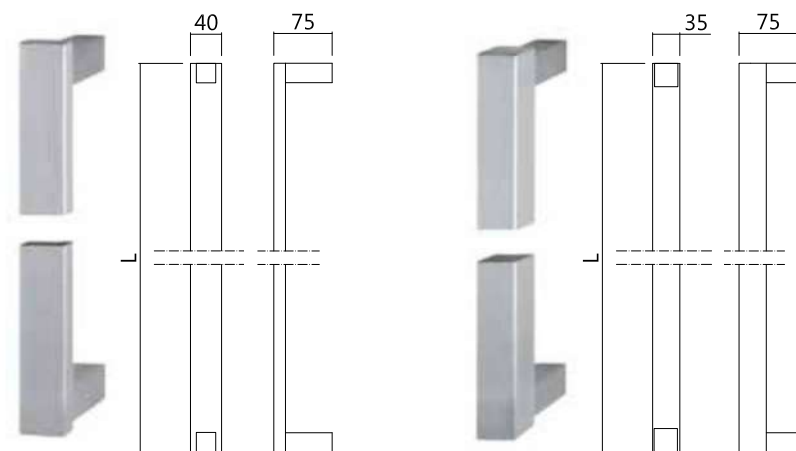

SEZIONE 40x15 mm
CODICE

MSX E23 J05
MSX E23 J02

■ ACCIAIO INOX SATINATO

SEZIONE 35x35 mm
CODICE

MSX E26 J05
MSX E26 J02

■ NERO OPACO

MANIGLIONI ESTERNI CON LETTORE BIOMETRICO

I maniglioni con lettore d'impronte digitale inserito nella parte posteriore del maniglione, sono realizzati in acciaio INOX AISI 316 e nella variante INOX verniciato NERO OPACO 9005 R TX. Sono disponibili in 3 forme (RETTANGOLARE 40x20 mm, TONDA ø34 mm, QUADRATA 30x30 mm) e in 5 diverse lunghezze (600, 800, 1000, 1500 e 1800 mm).

Il lettore d'impronte digitale con sensore capacitivo piatto consente la gestione del controllo degli accessi (lettore R8) e può essere gestito mediante un'APP su smartphone. Da remoto è possibile gestire anche il livello di luminosità e il sistema di accensione/spegnimento led.



Gstione con l'applicazione



Capacità di impronte digitali: 166 x 3



Numero amministratori: illimitato



N° uscite relè: 1 o 2

N Satellite

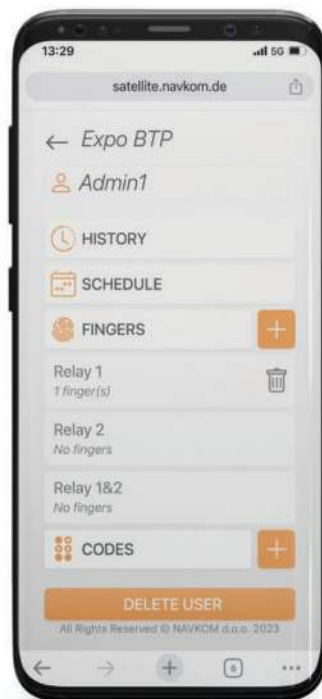

RETTANGOLARE 40x20 mm (DRITTO)

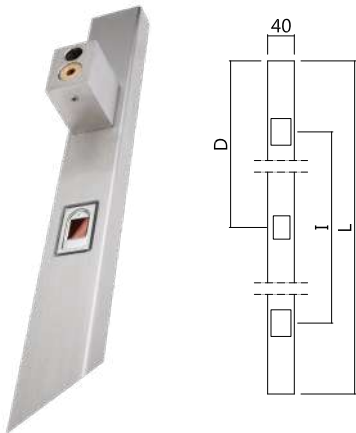

(L) LUNGHEZZA (mm)	(I) INTERASSE (mm)	(D) DISTANZA LETTORE BIOMETRICO (mm)	CODICE	CODICE
			■ ACCIAIO INOX SATINATO	■ NERO OPACO
600	400	200	MSX E60 J05	MSX E60 J02
800	600	200	MSX E61 J05	MSX E61 J02
1000	800	240	MSX E62 J05	MSX E62 J02
1500	1100	440	MSX E63 J05	MSX E63 J02
1800	1400	540	MSX E64 J05	MSX E64 J02

TONDO ø34 mm (DRITTO)

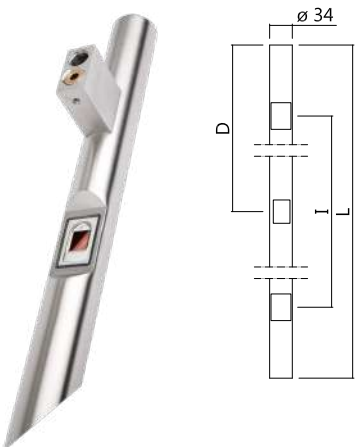

(L) LUNGHEZZA (mm)	(I) INTERASSE (mm)	(D) DISTANZA LETTORE BIOMETRICO (mm)	CODICE	CODICE
			■ ACCIAIO INOX SATINATO	■ NERO OPACO
600	400	200	MSX E65 J05	MSX E65 J02
800	600	200	MSX E66 J05	MSX E66 J02
1000	800	240	MSX E67 J05	MSX E67 J02
1500	1100	440	MSX E68 J05	MSX E68 J02
1800	1400	540	MSX E69 J05	MSX E69 J02

QUADRATO 30x30 mm (DRITTO)

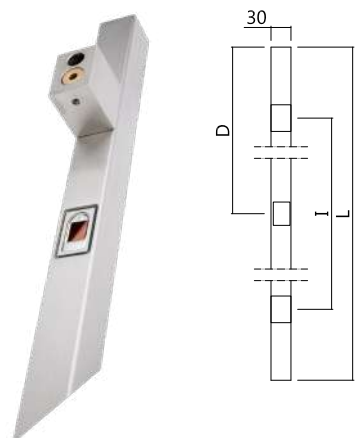

(L) LUNGHEZZA (mm)	(I) INTERASSE (mm)	(D) DISTANZA LETTORE BIOMETRICO (mm)	CODICE	CODICE
			■ ACCIAIO INOX SATINATO	■ NERO OPACO
600	400	200	MSX E70 J05	MSX E70 J02
800	600	200	MSX E71 J05	MSX E71 J02
1000	800	240	MSX E72 J05	MSX E72 J02
1500	1100	440	MSX E73 J05	MSX E73 J02
1800	1400	540	MSX E74 J05	MSX E74 J02

MANIGLIONI ESTERNI INCASSATI

■ ACCIAIO INOX SAT.



CODICE MIX E01 J05

DIMENSIONI 400 x 115 mm

■ ACCIAIO INOX SAT.



CODICE MIX E02 J05

DIMENSIONI 125 x 1200 mm

■ ACCIAIO INOX SAT.



CODICE MIX E03 J05

DIMENSIONI 200 x 200 mm

■ NERO OPACO



CODICE MIX E04 J02

DIMENSIONI 220 x 220 mm

■ NERO OPACO



CODICE	LUNGHEZZA
MIX E05 J02	60 x 300 mm
MIX E06 J02	60 x 500 mm
MIX E07 J02	60 x 800 mm
MIX E08 J02	60 x 1200 mm
MIX E09 J02	60 x 1600 mm
MIX E10 J02	TUTT'ALTEZZA

(DISPONIBILI NELLA FINITURA IN TINTA RAL DELLA PORTA E CON LED INTEGRATO)



MANIGLIONI ESTERNI

■ ACCIAIO INOX SAT.	
CODICE	MSX E27 J05
LUNGHEZZA	500 mm
INTERASSE	350 mm

■ OTTONE LUCIDO RESISTA	
CODICE	MSX E28 J10
INTERASSE	203 mm

■ OTTONE ARGENTO ANTICO	
CODICE	MSX E31 J03
INTERASSE	203 mm

■ NERO OPACO	
CODICE	MSX E31 J02
INTERASSE	203 mm

■ ACCIAIO INOX SAT.	
CODICE	MSX E39 J05
INTERASSE	300 mm

■ OTTONE CROMO SAT.	
CODICE	MSX E29 J11
INTERASSE	180 mm

■ OTTONE LUCIDO RESISTA	
CODICE	MSX E30 J10
INTERASSE	180 mm

■ BRONZO	
CODICE	MSX E31 J09
INTERASSE	210 mm

BATTENTI

	
BAT E01 J10 ■ OTTONE LUCIDO RESISTA	BAT E02 J03 ■ OTTONE ARGENTO ANTICO

DEFENDER

	■ OTTONE CROMO SAT.
DEF E05 J11	■ OTTONE LUCIDO
DEF E06 J12	■ NERO OPACO
DEF E07 J02	■ BRONZO
DEF E08 J09	

POMOLI FISSI

dotazione base *



* POM E01 J01
■ ALLUMINIO ARGENTO



POM E02 J11
■ OTTONE CROMO SAT.



POM E03 J10
■ OTTONE LUCIDO RESISTA



POM E04 J09
■ ALLUMINIO BRONZO



POM E05 J01
■ ALLUMINIO ARGENTO



POM E06 J05
■ ACCIAIO INOX SAT.



POM E07 J11
■ OTTONE CROMO SAT.

POMOLI GIREVOLI



POM E08 J01
■ ALLUMINIO ARGENTO



POM E09 J09
■ ALLUMINIO BRONZO



POM E10 J10
■ OTTONE LUCIDO RESISTA

SPIONCINO



SPI K01 J11 ■ OTTONE CROMO SAT.
SPI K02 J09 ■ ALLUMINIO BRONZO
SPI K03 J12 ■ OTTONE LUCIDO

MANIGLIERIA INTERNA

dotazione base *



* MAN K01 J01 ■ ALLUMINIO ARGENTO

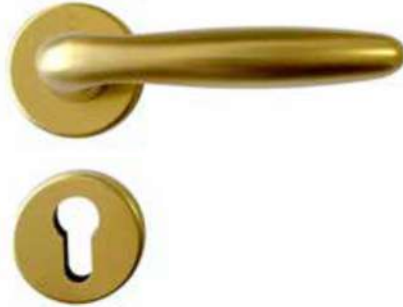

* MAN K02 J08 ■ ALLUMINIO ORO



* MAN K03 J09 ■ ALLUMINIO BRONZO



MAN K04 J05 ■ ACCIAIO INOX SAT.



MAN K05 J12 ■ OTTONE LUCIDO



MAN K17 J02 ■ NERO OPACO



MAN K06 J01 ■ ALLUMINIO ARGENTO



MAN K07 J05 ■ ACCIAIO INOX SAT.



MAN K14 J11 ■ OTTONE CROMO SAT.

MANIGLIERIA INTERNA



MAN K08 J01 ■ ALLUMINIO ARGENTO



MAN K09 J05 ■ ACCIAIO INOX SAT.



MAN K10 J01 ■ ALLUMINIO ARGENTO



MAN K11 J05 ■ ACCIAIO INOX SAT.



MAN K15 J05 ■ ACCIAIO INOX SAT.



MAN K16 J05 ■ ACCIAIO INOX SAT.

NOTTOLINO



NOT K01 J01 ■ ALLUMINIO ARGENTO

NOT K02 J09 ■ ALLUMINIO BRONZO

NOT K03 J11 ■ OTTONE CROMO SAT.

NOT K04 J12 ■ OTTONE LUCIDO



NOT K05 J01 ■ ALLUMINIO ARGENTO

NOT K06 J11 ■ OTTONE CROMO SAT.



NOT K07 J02 ■ NERO OPACO

FINITURE

KOPEN

L'esclusivo design delle porte Kopen viene valorizzato dall'ampia possibilità di combinazioni di materiali e da una vasta gamma di finiture che garantiscono un abbinamento perfetto per ogni ambiente.



FINITURE INTERNE / ESTERNE

ALLUMINIO

Sulle finiture è offerta di serie l'innovativa gamma di vernici in polvere goffrate Texture (R TX), progettata per garantire i più elevati standard di resistenza meccanica e durabilità. Questa finitura, oltre a valorizzare le prestazioni del prodotto, dona alle superfici un aspetto più caldo ed elegante rispetto alle tradizionali finiture lisce. Realizzate con polveri, pellicole e inchiostri sublimatici in classe 2 che garantiscono resistenza e alta durabilità nel tempo.

RAL STANDARD



K83 | 9016 R TX



K73 | 9010 R TX



K74 | 1013 R TX

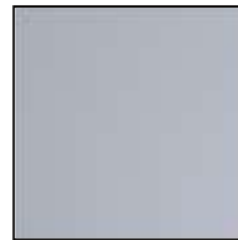

K75 | 9006 R TX

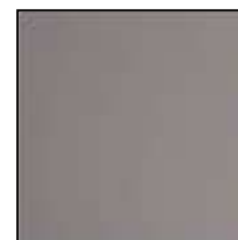

K76 | 9007 R TX

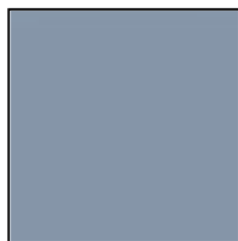

K77 | 7001 R TX



K78 | 7016 R TX



K79 | 9005 R TX



K80 | 6005 R TX



Y78 | 8017 R TX

RAL SPECIAL

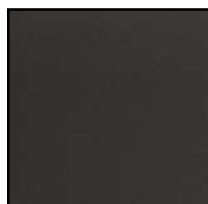

K15 | P G CE



K17 | 6005 MA

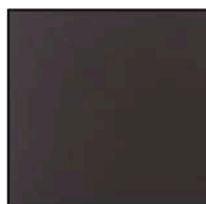

K23 | P G R



K24 | PGMA



K42 | P GRAF



K81 | 8014 R TX



K86 | 7035 R TX



K87 | 7037 R TX



K88 | 7039 R TX



K90 | 5010 R TX



K91 | 6009 R TX



K93 | SK13SD

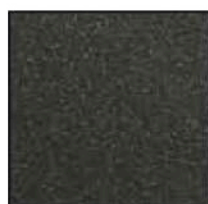

K94 | SK14SD



K95 | SK15SD

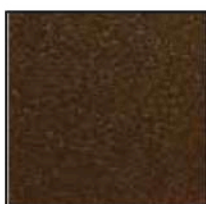

K96 | SK16SD



K97 | 1019 R TX

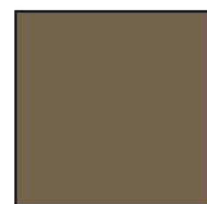

K98 | 7006 R TX



K99 | 8019 R TX



F01 | 6021 R TX



F12 | 7040 R TX



F02 | 5014 R TX

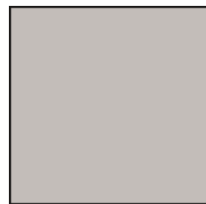

F14 | 9002 R TX

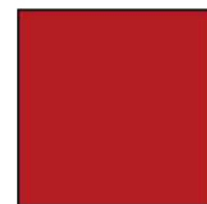

F16 | 3003 R TX

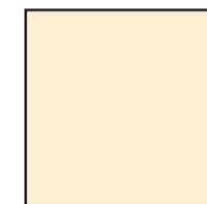

F31 | BEIGE

RAL FUORI CAMPIONARIO

Possono essere richieste altre finiture RAL fuori campionario, previa fattibilità della KOPEN.

Le finiture realizzabili fanno parte della serie Texture (finiture lucide ed opache non sono realizzabili per motivi qualitativi).

EFFETTO LEGNO STANDARD

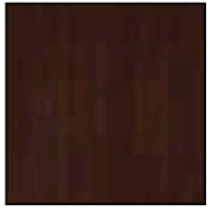

K44 | PK A3 *

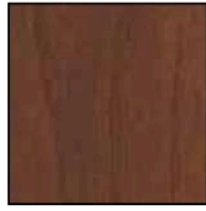

K45 | PK A7 *

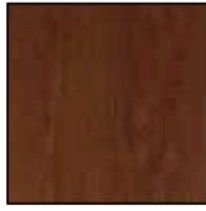

K46 | PK A16 *

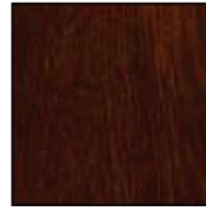

Y69 | PK A31 *



Y19 | PK RL3 **

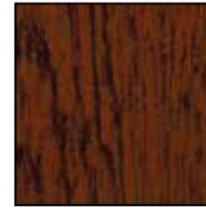

Y16 | PK RL4 **

* finiture SUBLIMATE (decorazione da pellicola) realizzabili su lavorazioni incise

** finiture RELIF (polvere su polvere) realizzabili su lavorazioni fresate

EFFETTO LEGNO/METALLIKA SPECIAL



K43 | PK A2



K47 | PK A18



K52 | PK T2



T05 | PK A64



T09 | PK A73



Y83 | PK A70



Y81 | PK RL13



K58 | PK MT10



T01 | PK MT12

FINITURE INTERNE / ESTERNE

LEGNO

La nuova selezione di essenze è disponibile solo per la linea Natural, in multistrato okumè spessore 14 mm.

KDS 100



INSTALLAZIONE
ALL'ESTERNO
OUTDOOR
INSTALLATION



M01
OKOUMÈ TINTO NATURALE



M02
OKOUMÈ TINTO
SBIANCATO



M03
OKOUMÈ TINTO CILIEGIO



M04
OKOUMÈ TINTO ROVERE



M05
OKOUMÈ TINTO
MOGANO CHIARO



M06
OKOUMÈ TINTO
CASTAGNO CHIARO



M07
OKOUMÈ TINTO NOCE MEDIO



M08
OKOUMÈ TINTO
WENGÈ

FINITURE CERNIERE

LE CERNIERE SONO VERNICIATE NELLO STESSO COLORE DELLA PORTA (COLORE RAL DEL LATO INTERNO).
IN ALTERNATIVA SONO DISPONIBILI LE NUOVE FINITURE: OSSIDATO ARGENTO (J01), VERNICIATO BRONZO (J09) E
OSSIDATO OTTONE LUCIDO (J10).



J01
OSSIDATO ARGENTO

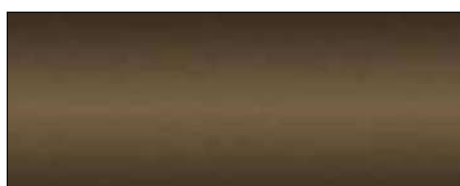

J09
VERNICIATO BRONZO



J10
OSSIDATO OTTONE LUCIDO

LAMINATO

Per alcuni modelli è possibile scegliere, in alternativa al rivestimento in alluminio, il rivestimento, il rivestimento interno in MDF laminato.

KDS 100

LAMINATO STANDARD

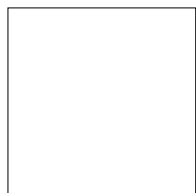

W01
BIANCO



W18
BIANCO MATRIX



W03
ROVERE



W02
CILIEGIO



W04
NOCE

LAMINATO SPECIAL



W20
PALISSANDRO CHIARO



W22
ATLAS GLACIALE



W24
ETNA TAIGA



W14
LINO CANCUN



W23
ETNA ESTEPA

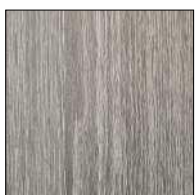

W26
MESURA JOPLIN



W25
ROVERE R-6



W19
NOCE BOREALE



W21
WENGUE'

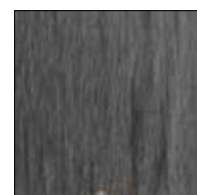

W17
ROVERE NERO

VETRI

KOPEN

La linea di vetri Kopen nasce per valorizzare il vetro protagonista del design della porta di ingresso.

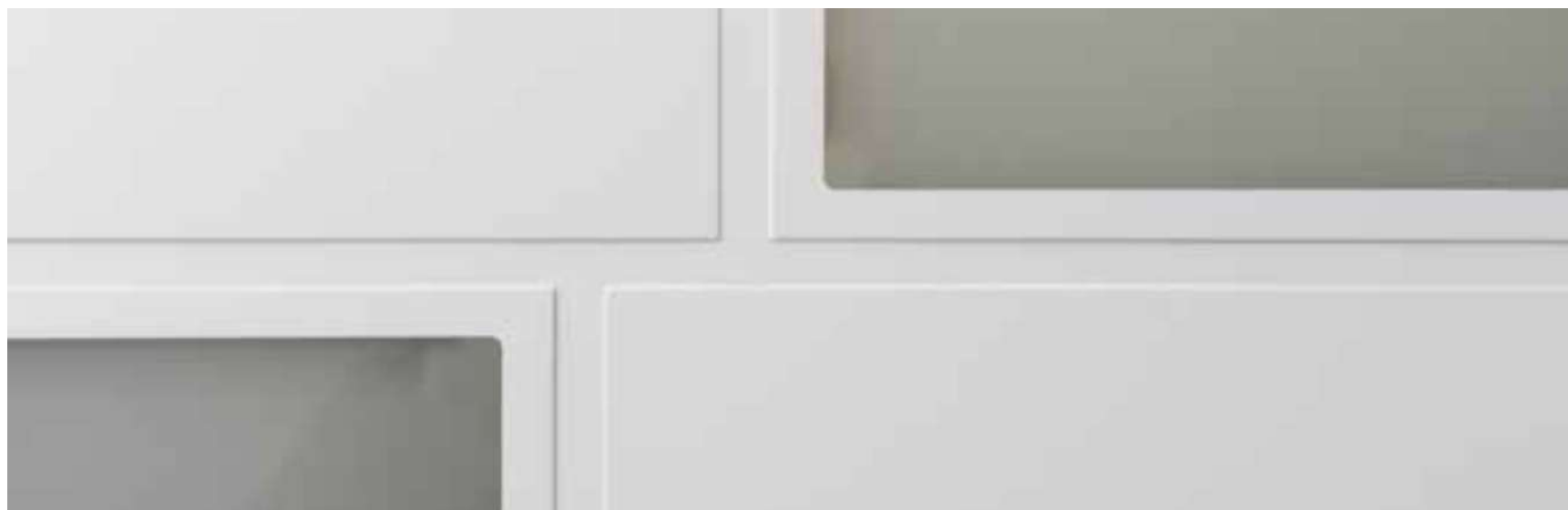

VETRI



J22
SATINATO BIANCO B.E.

J21
TRASPARENTE B.E.

J14
SATINATO BRONZO B.E.

J15
SATINATO FUMÈ B.E.

J27
RIFLETTENTE ANTELIO
CHIARO B.E.

J32
RIFLETTENTE GRIGIO B.E.

VETRI CON MOTIVI

LINEAR

Punti e linee che scorrono sul vetro ricchi di vitalità e trasmettono vibrazioni di energia. Il minimalismo è intenzionale per accompagnare, senza sovrastarle, le linee essenziali del design contemporaneo.

MATERICA

Materie, texture, atmosfere ritrovano nel vetro espressioni nuove grazie a tecniche di lavorazione particolari che ne modificano la superficie in relazione all'effetto visivo e tattile desiderato e ne fanno un componente unico per l'architettura e il design.

DESIGN

Tecnologia e creatività per nuovi motivi che danno un'impronta all'arredo e impreziosiscono lo spazio di ingresso grazie alla leggerezza di satinature e alle preziose incisioni profonde, valorizzate dalla vivacità della smaltatura.



BASIC

J16

PUNTO

J17

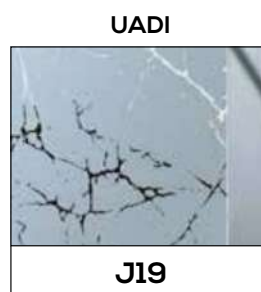

UADI

J19

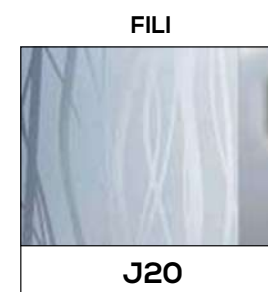

FILI

J20

VETRI ANTIVANDALISMO

Vetri antisfondamento 44.6 (classe P5A) nelle versioni SATINATO BIANCO o TRASPARENTE. Sono previsti di serie nelle porte vetrate certificate all'effrazione in Classe RC2 o RC3.

KOPEN



CREDITI

Il catalogo ed i prodotti illustrati sono soggetti ad aggiornamenti tecnici ed estetici. KOPEN Srl si riserva il diritto di apportare qualsiasi tipo di variazione, anche senza preavviso, al fine di aggiornare e migliorare il catalogo ed i prodotti rappresentati. Le texture ed i colori hanno valore indicativo come pure le misure indicate espresse in millimetri.

Il presente catalogo annulla e sostituisce i precedenti.

VERSIONE 01 2026

KOPEN

Via Tiburtina Valeria Km. 127,5
67041 Aielli (AQ) – Italy
Tel. +39 0863.78861
Mail: info@kopendoors.com
Web: www.kopendoors.com